



**DOMADECO**

2018



GLOSSY DOORS



XTREME MATT DOORS



### STANDARD OPTION

- » edge whitout rebate
- » door leaf coated with high gloss laminate or Xtreme Matt
- » stiles and rails made of MDF
- » magnetic lock for simple key, for bathroom lock, for cylinder lock or economic lock
- » glass pane MAT DRE 4 mm thick in ILIS 1-3
- » core made of 20 mm MDF board in ILIS 4
- » complex safe 8 mm glass pane MAT DRE in ILIS 5
- » sockets for 3 hidden concealed W1078 hinges

### OPTION WITHOUT ADDITIONAL CHARGE

- » glass pane DECORMAT BROWN, DECORMAT GRAPHITE and transparent glass 4 mm in ILIS 1 - 3
- » complex safe 8 mm glass pane transparent in ILIS 5
- » holes for ventilation sleeves
- » sliding doors - 2043 mm height

### OPTIONS AVAILABLE WITH EXTRA CHARGE

- » steel ventilation sleeves
- » door leaf „100”
- » ventilation undercut
- » cover-up strip for double leaf non-rebated door
- » double leaf door

NOTE: Door leaf are equipped with sockets for hinges, prepared for future assembly. Non-rebated door frames are equipped with hinges.

Sliding system - it is possible to apply to the collection SPAZIO CD sliding system in the standard height of 2043 mm. More information on p. 10.

**High gloss laminate** 0,7-0,8 mm thick, it is modern design of laminate with high degree of gloss, which gives mirror reflection effect. It is characterised by perfectly smooth surface with improved resistance for scratches.

**Xtreme Matt** 0,8 mm thick it is innovative laminate with matt non-reflective structure. Xtreme Matt surface is resistant to abrasion and easy to maintain. Structure additionally was reinforced with Anti-Finger-Print feature, which protect laminate surface from finger prints and traces of fat.

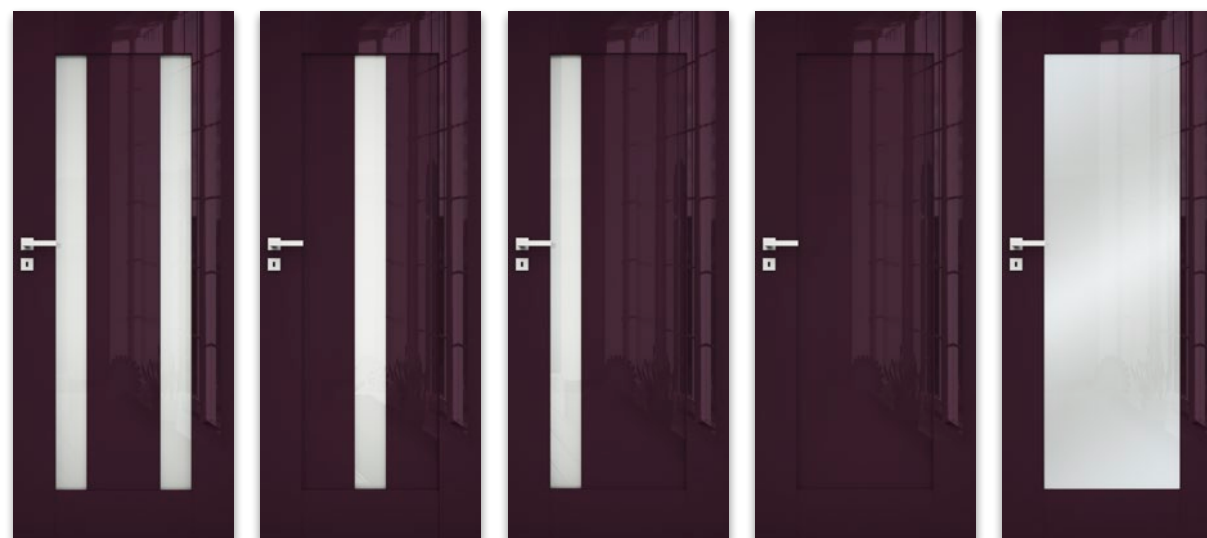

ILIS 1

ILIS 2

ILIS 3

ILIS 4

ILIS 5

STANDARD GLOSS

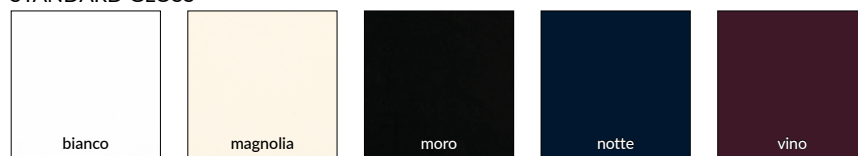

METALLIC GLOSS

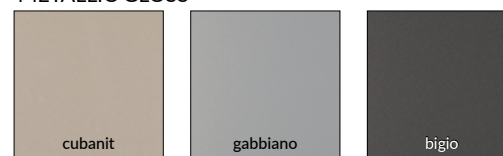

XTREME MATT

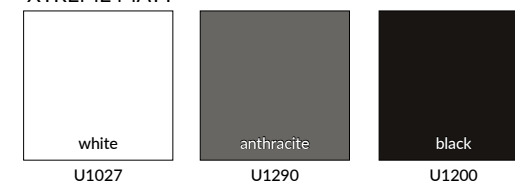



### STANDARD OPTION

- » edge whitout rebate
- » door leaf coated with high gloss laminate or Xtreme Matt
- » stiles and rails made of MDF
- » magnetic lock for simple key, for bathroom lock, for cylinder lock or economic lock
- » glass pane MAT DRE 4 mm thick
- » sockets for 3 hidden concealed W1078 hinges

### OPTION WITHOUT ADDITIONAL CHARGE

- » glass pane DECORMAT BROWN, DECORMAT GRAPHITE and transparent glass pane
- » holes for ventilation sleeves
- » sliding doors - 2043 mm height

### OPTIONS AVAILABLE WITH EXTRA CHARGE

- » steel ventilation sleeves
- » door leaf „100”
- » ventilation undercut
- » cover-up strip for double leaf non-rebated door
- » double leaf door

NOTE: Door leaf are equipped with sockets for hinges, prepared for future assembly. Non-rebated door frames are equiped with hinges.

Sliding system - it is possible to apply to the collection SPAZIO CD sliding system in the standard height of 2043 mm. More information on p. 10.

**High gloss laminate** 0,7-0,8 mm thick, it is modern design of laminate with high degree of gloss, which gives mirror reflection effect. It is characterised by perfectly smooth surface with improved resistance for scratches.

**Xtreme Matt** 0,8 mm thick it is innovative laminate with matt non-reflective structure. Xtreme Matt surface is resistant to abrasion and easy to maintain. Structure additionally was reinforced with Anti-Finger-Print feature, which protect laminate surface from finger prints and traces of fat.



NELLA 1

NELLA 2

NELLA 3

NELLA 4

NELLA 5

NELLA 6

NELLA 7

STANDARD GLOSS

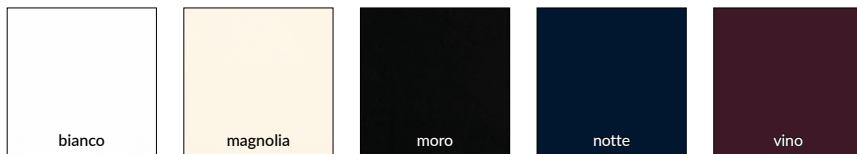

METALLIC GLOSS



XTREME MATT





### STANDARD OPTION

- » edge whitout rebate
- » core made of perforated chipboard
- » door leaf coated with high gloss laminate or Xtreme Matt
- » edge banding in door leaf colour
- » magnetic lock for simple key, for bathroom lock, for cylinder lock or economic lock
- » sockets for 3 hidden concealed W1078 hinges

### OPTION WITHOUT ADDITIONAL CHARGE

- » holes for ventilation sleeves
- » sliding doors - 2043 mm height

### OPTIONS AVAILABLE WITH EXTRA CHARGE

- » edge banding pattern
- » steel ventilation sleeves
- » door leaf „100”
- » ventilation undercut
- » cover-up strip for double leaf non-rebated door
- » aluminum ventilation grille
- » double leaf door

NOTE: Door leaf are equipped with sockets for hinges, prepared for future assembly. Non-rebated door frames are equipped with hinges. steel BULAJ - available only MAT or transparent glass pane.

Sliding system - it is possible to apply to the collection SPAZIO CD sliding system in the standard height of 2043 mm. More information on p. 10.

**High gloss laminate** 0,7-0,8 mm thick, it is modern design of laminate with high degree of gloss, which gives mirror reflection effect. It is characterised by perfectly smooth surface with improved resistance for scratches.

**Xtreme Matt** 0,8 mm thick it is innovative laminate with matt non-reflective structure. Xtreme Matt surface is resistant to abrasion and easy to maintain. Structure additionally was reinforced with Anti-Finger-Print feature, which protect laminate surface from finger prints and traces of fat.



SILIA 10  
bianco

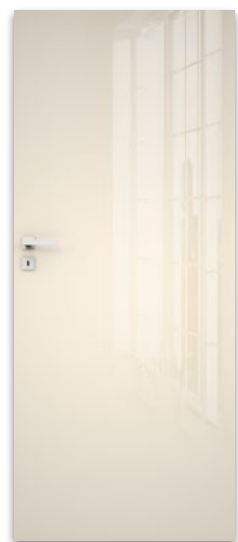

SILIA 10  
magnolia



SILIA 10  
gabbiano



SILIA 10  
notte

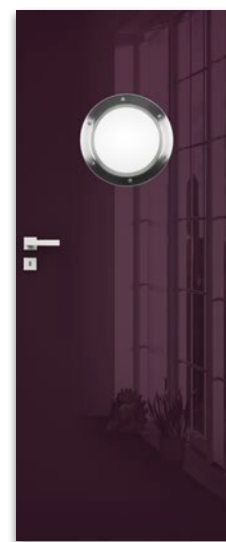

steel BULAJ  
vino

There is possibility to choose edge banding only in decor bianco.

### EDGE BANDING PATTERNS



theme 1

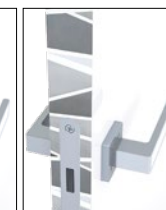

theme 2

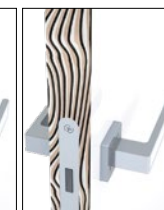

theme 3

### STANDARD GLOSS

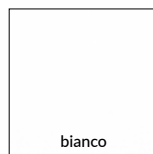

bianco

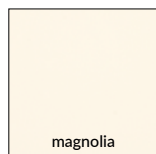

magnolia

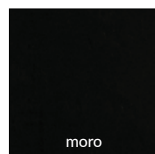

moro



notte



vino

### METALLIC GLOSS



cubanit



gabbiano



bigio

### XTREME MATT



white

U1027



anthracite

U1290



black

U1200



### STANDARD OPTION

- » edge whitout rebate
- » door leaf coated with high gloss laminate or Xtreme Matt
- » door leaf frame made of MDF, narrow element with constant width, wide element with variable width
- » core made of perforated chipboard
- » magnetic lock for simple key, for bathroom lock, for cylinder lock or economic lock
- » complex safe MAT DRE 8 mm glass pane
- » sockets for 3 hidden concealed W1078 hinges

### OPTION WITHOUT ADDITIONAL CHARGE

- » complex safe transparent 8 mm glass pane
- » sliding doors - 2043 mm height

### OPTIONS AVAILABLE WITH EXTRA CHARGE

- » door leaf „100”
- » cover-up strip for double leaf non-rebated door
- » double leaf door

NOTE: Door leaf are equipped with sockets for hinges, for future assembly. Non-rebated door frames are equipped with hinges. There is no possibility to make ventilation undercut.

Sliding system - it is possible to apply to the collection SPAZIO CD sliding system in the standard height of 2043 mm. More information on p. 10.

**High gloss laminate** 0,7-0,8 mm thick, it is modern design of laminate with high degree of gloss, which gives mirror reflection effect. It is characterised by perfectly smooth surface with improved resistance for scratches.

**Xtreme Matt** 0,8 mm thick it is innovative laminate with matt non-reflective structure. Xtreme Matt surface is resistant to abrasion and easy to maintain. Structure additionally was reinforced with Anti-Finger-Print feature, which protect laminate surface from finger prints and traces of fat.



# VETRO D2

Glossy and matt non-rabated doors



VETRO D2  
bianco



VETRO D2  
moro



VETRO D2  
notte



VETRO D2  
vino

## STANDARD GLOSS



bianco

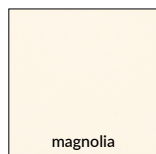

magnolia

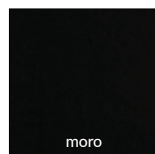

moro



notte



vino

## METALLIC GLOSS

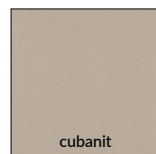

cubanit



gabbiano

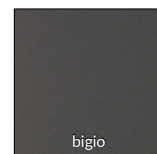

bigio

## XTREME MATT



white

U1027



anthracite

U1290



black

U1200

# Door handles

# Sliding system SPAZIO CD mounted on-wall



handle MEDA - shiny chrome  
insert in high gloss laminate colours  
and Xtreme Matt



handle MALIBU - shiny chrome



handle DUO - graphite/chrome



handle DUO - nickel satin



handle TOTAL - shiny chrome



handle TOTAL - brushed nickel mat



backplate for  
simple key



backplate for  
simple key



Simple key  
backplate



Simple key  
backplate



backplate for  
simple key



backplate for  
simple key



backplate for  
cylinder lock



backplate for  
cylinder lock



backplate for  
cylinder lock



backplate for  
cylinder lock



backplate for  
cylinder lock



backplate for  
cylinder lock



backplate for  
toilet lock



backplate for  
toilet lock



backplate for  
toilet lock



backplate for  
toilet lock



backplate for  
toilet lock



backplate for  
toilet lock

## round handle



gold



gold satin



chrome



Satin chrome

## oval handle



gold



gold satin



chrome



Satin chrome

One set of door handle for single door leaf  
consist of 2 pcs.

## SPAZIO CD

On-wall mounted sliding system with anodized guide channel and rectangular blade. Is designated for panel doors and frame construction doors.

## WHOLE SET COMPRISES OF:

- guide channel with side caps
- system sliding trolleys
- door leaf hangers
- bottom stopper
- assembly kit (screws and bolts)

To complete the system, it is necessary to purchase sliding door leaf with a handle. Handles should be purchased separately.

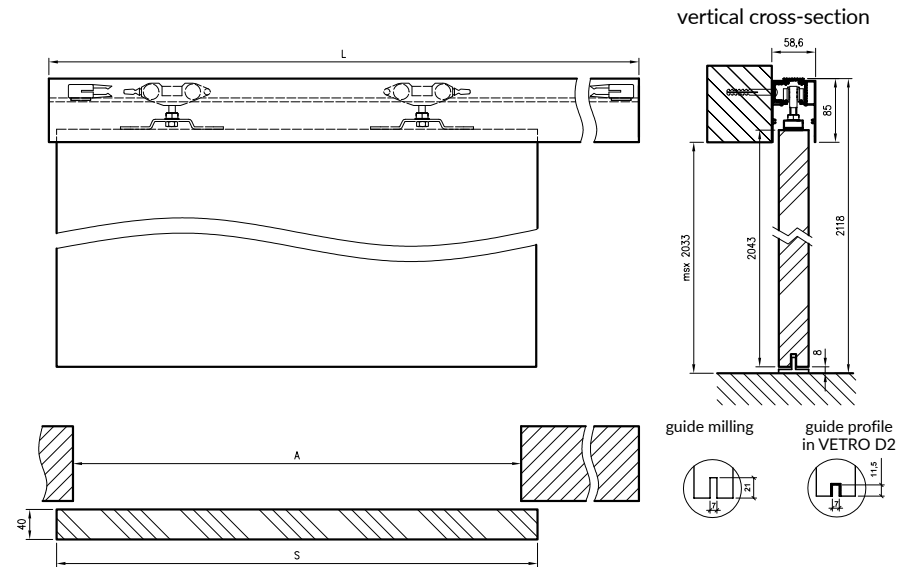

Door leaf width: single leaf door "60" - "100".

	A	S	L
„60”	600	644	1300
„70”	700	744	1500
„80”	800	844	1700
„90”	900	944	1900
„100”	1000	1044	2100

A - width of wall passage  
S - width of door leaf unit  
L - length of guide channel

# Technical informations

## CONSTRUCTION

Adjustable door frame is made of high quality wood-based MDF board. On its visual side it is entirely coated with high gloss laminate or Extreme Matt with 0,7 - 0,8 mm thickness. Its construction allows to be used with door leaf with thickness of 40 mm and its design allows to be used on walls ranging between 75-320 mm, also there is possibility for additional adjustment of + 20 mm.

**Glossy laminate** 0,7-0,8 mm thick, it is laminate with high gloss, which consist of an acrylic layer and a layer of coextruded styrene copolymer.

**Xtreme Matt** laminate with 0,8 mm thickness is based on melamine resin with an upper layer of electron quenched function. Structure additionally was reinforced with Anti-Finger-Print feature, which protect laminate surface from finger prints and traces of fat.

## Application

Adjustable non-rebated door frame coated with high gloss laminate or Xtreme Matt can be used with DRE collections: ILIS, NELLA, SILIA and VETRO D2 non-rebated door leaf.

## SET CONTAINS

Main beam (one horizontal and two vertical elements) with wide angular architrave (80 mm) with small rounding angles of the cross-section profile (R2), door seal, a set of hinges, all necessary components for the installation of door frames in accordance with the supplied instruction. Door frames are packed in cardboard boxes.

for single-leaf doors

	A	B	C	D	E
60	627	651	671	711	811
70	727	751	771	811	911
80	827	851	871	911	1011
90	927	951	971	1011	1111
100	1027	1051	1071	1111	1211

for double-leaf doors

	A	B	C	D	E
120	1274	1298	1318	1378	1458
130	1374	1398	1418	1478	1558
140	1474	1498	1518	1578	1658
150	1574	1598	1618	1678	1758
160	1674	1698	1718	1778	1858
170	1774	1798	1818	1878	1958
180	1874	1898	1918	1978	2058

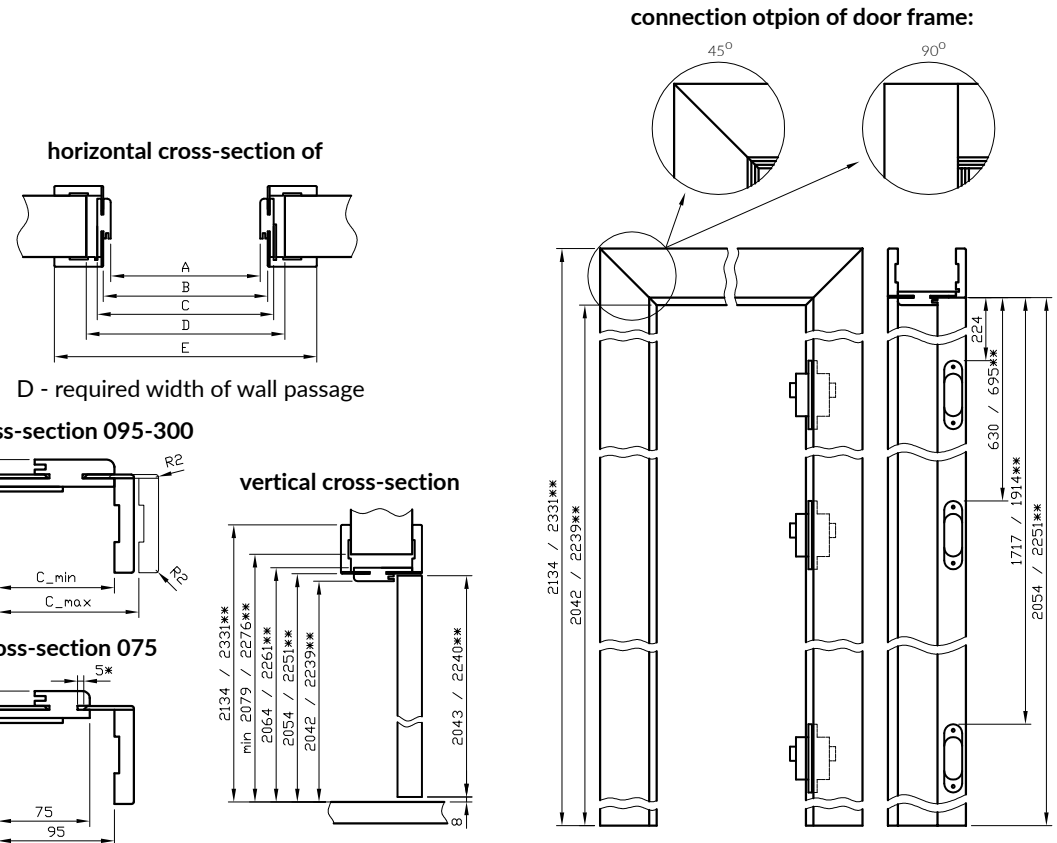

\*NOTE: 075-095 door frame has a different cross-section, for a 75-89 mm wall thickness, it will be necessary to shorten the moving angular architrave.

\*\* for door leaf dimension 2240 mm



**DOMADECO**

