



DOMADECO

CATALOGUE 2018

EDITION 1

ISO
9001





folding doors FOLDE 10 - white matt

EXPLANATIONS:

























- | | |
|---|--|
|  panel doors, DOMADECO - Cell veneer |  panel doors, laminate CPL |
|  frame construction doors, DOMADECO - |  frame construction doors, laminate CPL |
|  Cell veneer entrance doors, - Cell veneer |  entrance doors, laminate CPL |
|  technical doors, - Cell veneer |  technical doors, laminate CPL |
|  panel doors, 3D veneer |  panel doors, natural veneer |
|  frame construction doors, 3D veneer |  frame construction doors, natural veneer |
|  entrance doors, 3D veneer |  entrance doors, natural veneer |
|  technical doors, 3D veneer |  glass doors |
|  panel doors, lacquered HDF board |  panel doors Sara Eco |
|  frame construction doors, Finish veneer |  smoke-proof technical doors |
|  panel doors, painted |  fire resistant technical doors |
|  frame construction doors, painted |  anti-burglary doors |

TABLE OF CONTENTS

FRAME CONSTRUCTION DOORS

Emena	5
Ena	6
Verano.....	7
Trevi.....	8
Triesta.....	9
NEW Solte	11
NEW Reva	13
Nestor	15
Auri	17
Elsa.....	19
Fosca	20
Premium	21
Piano	23
Scala	25
Sinco.....	27
Vetro A.....	29
Vetro B.....	31
Vetro C.....	33
Vetro D	35

FRAME CONSTRUCTION DOORS NATURA

Vetro natura A.....	37
Vetro natura B.....	39
Premium natura	40
Dova natura	41
Scala A natura.....	42

FRAME CONSTRUCTION DOORS PAINTED

Lexa	43
Even.....	44
Nestor	45

FRAME CONSTRUCTION DOORS LAMINATE CPL

NEW Tixa	47
Tizano.....	49

PANEL DOORS

NEW Rivia	51
Galeria Alu.....	53
Aldea	55
Arte B.....	57
Carla	59
NEW Blanco	61
Finea and Finea B.....	63
NEW Deco	65
Modern	67
Kanon.....	69
Idea	71
Plus	73
Standard	75
Rim.....	77
Arte.....	79
Fano.....	80
Linea.....	81
Classic	82
Ascada.....	83
Lack	84-85

PANEL DOORS NATURA

Duero natura Alu	87
Arte natura.....	89
Standard natura	90-91
Galeria natura.....	92-93
GALERIA natura ALU.....	94-95
Galeria natura non-rebated.....	96
Standard natura non-rebated	97
Galeria natura Alu non-rebated.....	99

PANEL DOORS PAINTED

Duo.....	101
Uni	103
Binito.....	105

PANEL DOORS LAMINATE CPL

Standard CPL.....	106
-------------------	-----

PANEL DOORS WITH VARIABLE HEIGHTS

Standard 10	107
Modern	108
Plus.....	109

SLIDING SYSTEM

Wall mounted sliding system.....	111
Glass doors sliding system	113
wall-mounted sliding system SPAZIO CD	115
Sliding system doors hidden in the wall (pocket system) PA.....	117

FOLDING DOORS

Folde.....	119
------------	-----

DOORS WITH HIDDEN DOOR FRAME

Sara Eco	120-122
----------------	---------

SIDE PANELS

Frame construction.....	123
Panel construction	124
Side panel Natura.....	125

TRANSOM LIGHTS AND SIDELIGHTS

TRANSOM LIGHTS AND SIDELIGHTS ..	126-127
----------------------------------	---------

INTERIOR ENTRANCE PANEL DOORS

Enter natura.....	128
Accessories	129
Enter/Solid.....	130-133
SOLID RC2.....	134-135

TECHNICAL DOORS

Anti-burglary fire resistant Forca.....	136
Fire resistant door leaf Athos.....	137

GLASS DOORS

Galla.....	138
Gracca	139-140
Gossa.....	141-142
Glass doors technical informations	143-144

DOOR FRAMES

Fixed door frames	145
Adjustable door frames.....	146-147
Adjustable door frames with variable heights.....	148
Adjustable non-rebated door frames.....	149
Adjustable non-rebated door frames with variable heights.....	150
Adjustable tunnel	151
Hybrid steel door frames.....	152-153
NEW Steel door frames	154
steel door frame	155

ACCESSORIES, ADDITIONAL INFORMATIONS

NEW Door handles	156-163
NEW Veneer colours	164-165
Glass panes patterns	166-167
Architraves and skirting boards.....	168
Ventilation accessories and other.....	169
Technical informations	170-178



Emena - anthracite elm

Decor
Cell

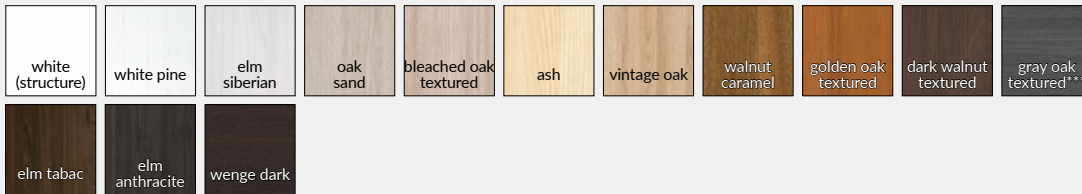

STANDARD OPTION

- » stiles and rails made of MDF
- » glass pane MAT DRE 4 mm thick

OPTION WITHOUT ADDITIONAL CHARGE

- » glass pane DECORMAT BROWN, DECORMAT GRAPHITE and transparent glass pane
- » holes for ventilation sleeves

OPTIONS AVAILABLE WITH EXTRA CHARGE

- » steel ventilation sleeves
- » plastic ventilation sleeves
- » non-rebated door leaf
- » door leaf „90” and „100”
- » ventilation undercut
- » cover-up strip for double leaf non-rebated door
- » double leaf door

NOTE: It is required to use together with EMENA door leaf model door frames equipped with 3 hinges. Left door unit is mirror reflection of the right door leaf unit.

REBATED DOOR LEAF

- » straight edge **fig. 1**
- » 3 silver screw-in pivot hinges
- » single-point mortise lock for simple key, for bathroom lock, for cylinder lock or economic lock

NON-REBATED DOOR LEAF (extra charge)

- » edge without rebate **fig. 2**
- » sockets for 3 hidden concealed W1078 hinges (non-rebated door frames are equipped with hinges)
- » magnetic lock for simple key, for bathroom lock, for cylinder lock or economic lock

SLIDING SYSTEM DOOR LEAF

- » edge without rebate **fig. 2**
- » socket for hook lock and/or for handles

fig. 1

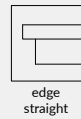

fig. 2



STANDARD OPTION

- » stiles and rails made of MDF
- » glass pane MAT DRE 4 mm thick

OPTION WITHOUT ADDITIONAL CHARGE

- » glass pane DECORMAT BROWN, DECORMAT GRAPHITE and transparent glass pane
- » holes for ventilation sleeves

OPTIONS AVAILABLE WITH EXTRA CHARGE

- » steel ventilation sleeves
- » plastic ventilation sleeves
- » non-rebated door leaf
- » door leaf „90” and „100”
- » ventilation undercut
- » cover-up strip for double leaf non-rebated door
- » double leaf door

REBATED DOOR LEAF

- » straight edge **fig. 1**
- » 3 silver screw-in pivot hinges
- » single-point mortise lock for simple key, for bathroom lock, for cylinder lock or economic lock

NON-REBATED DOOR LEAF (extra charge)

- » edge without rebate **fig. 2**
- » sockets for 3 hidden concealed W1078 hinges (non-rebated door frames are equipped with hinges)
- » magnetic lock for simple key, for bathroom lock, for cylinder lock or economic lock

SLIDING SYSTEM DOOR LEAF

- » edge without rebate **fig. 2**
- » socket for hook lock and/or for handles

fig. 1



fig. 2



NOTE: It is required to use together with ENA door leaf model door frames equipped with 3 hinges.



Decor DRE-Cell	white (structure)	white mat	white pine	elm siberian	vanilla***	oak sand	bleached oak textured	ash	golden oak textured	dark walnut textured	gray oak textured***	elm tabac	elm anthracite
	wenge dark	walnut caramel	vintage oak										
	grand oak	elm	walnut american	ebony	polish oak 3D								

*** decor available only in horizontal wood grain

STANDARD OPTION

- » stiles and rails made of MDF
- » glass pane MAT DRE 4 mm thick

OPTION WITHOUT ADDITIONAL CHARGE

- » glass pane DECORMAT BROWN, DECORMAT GRAPHITE and transparent glass pane
- » holes for ventilation sleeves

OPTIONS AVAILABLE WITH EXTRA CHARGE

- » steel ventilation sleeves
- » plastic ventilation sleeves
- » non-rebated door leaf
- » door leaf „90” and „100”
- » ventilation undercut
- » cover-up strip for double leaf non-rebated door
- » double leaf door

NOTE: It is required to use together with VERANO door leaf model door frames equipped with 3 hinges.

REBATED DOOR LEAF

- » straight edge **fig. 1**
- » 3 silver screw-in pivot hinges
- » single-point mortise lock for simple key, for bathroom lock, for cylinder lock or economic lock

NON-REBATED DOOR LEAF (extra charge)

- » edge without rebate **fig. 2**
- » sockets for 3 hidden concealed W1078 hinges (non-rebated door frames are equipped with hinges)
- » magnetic lock for simple key, for bathroom lock, for cylinder lock or economic lock

SLIDING SYSTEM DOOR LEAF

- » edge without rebate **fig. 2**
- » socket for hook lock and/or for handles

fig. 1

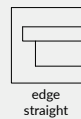
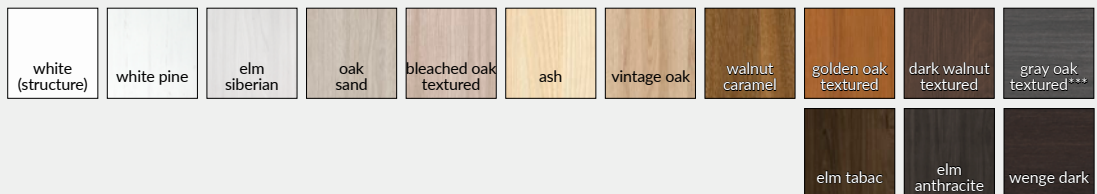

fig. 2



Decor
DRE-Cell

STANDARD OPTION

- » stiles and rails made of MDF
- » glass pane MAT DRE 4 mm thick
- » profiled 19mm MDF panels

OPTION WITHOUT ADDITIONAL CHARGE

- » glass pane DECORMAT BROWN, DECORMAT GRAPHITE and transparent glass pane
- » holes for ventilation sleeves

OPTIONS AVAILABLE WITH EXTRA CHARGE

- » steel ventilation sleeves
- » plastic ventilation sleeves
- » non-rebated door leaf
- » door leaf „90” and „100”
- » ventilation undercut
- » cover-up strip for double leaf non-rebated door
- » double leaf door

REBATED DOOR LEAF

- » straight edge **fig. 1**
- » 3 silver screw-in pivot hinges
- » single-point mortise lock for simple key, for bathroom lock, for cylinder lock or economic lock

NON-REBATED DOOR LEAF (extra charge)

- » edge without rebate **fig. 2**
- » sockets for 3 hidden concealed W1078 hinges (non-rebated door frames are equipped with hinges)
- » magnetic lock for simple key, for bathroom lock, for cylinder lock or economic lock

SLIDING SYSTEM DOOR LEAF

- » edge without rebate **fig. 2**
- » socket for hook lock and/or for handles

fig. 1



fig. 2



NOTE: It is required to use together with TREVI door leaf model door frames equipped with 3 hinges. Left door unit is mirror reflection of the right door leaf unit, concerns TREVI 1-2.



Decor
DRE-Cell

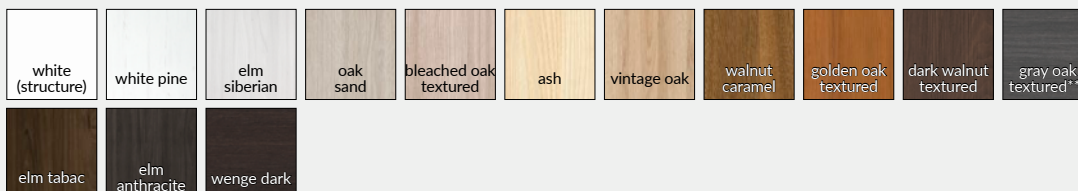

STANDARD OPTION

- » stiles and rails made of MDF
- » glass pane MAT DRE 4 mm thick

OPTION WITHOUT ADDITIONAL CHARGE

- » glass pane DECORMAT BROWN, DECORMAT GRAPHITE and transparent glass pane
- » holes for ventilation sleeves

OPTIONS AVAILABLE WITH EXTRA CHARGE

- » steel ventilation sleeves
- » plastic ventilation sleeves
- » non-rebated door leaf
- » door leaf „90” and „100”
- » ventilation undercut
- » cover-up strip for double leaf non-rebated door
- » double leaf door

REBATED DOOR LEAF

- » straight edge **fig. 1**
- » 3 silver screw-in pivot hinges
- » single-point mortise lock for simple key, for bathroom lock, for cylinder lock or economic lock

NON-REBATED DOOR LEAF (extra charge)

- » edge without rebate **fig. 2**
- » sockets for 3 hidden concealed W1078 hinges (non-rebated door frames are equipped with hinges)
- » magnetic lock for simple key, for bathroom lock, for cylinder lock or economic lock

SLIDING SYSTEM DOOR LEAF

- » edge without rebate **fig. 2**
- » socket for hook lock and/or for handles

fig. 1

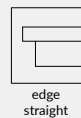
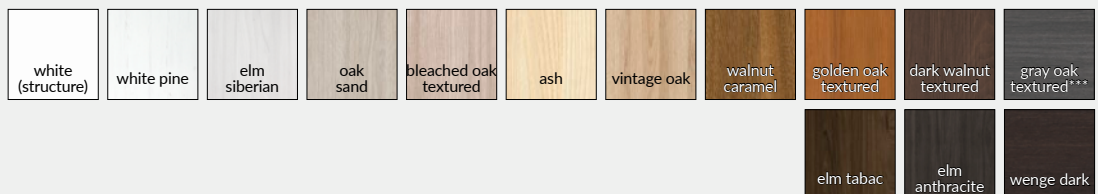

fig. 2



NOTE: It is required to use together with TRIESTA door leaf model door frames equipped with 3 hinges. Left door unit is mirror reflection of the right door leaf unit.



Decor
DRE-Cell



SOLTE 3 - white mat

Decor DRE-Cell	white (structure)	white mat	white pine	elm siberian	oak sand	bleached oak textured	ash	vintage oak	walnut caramel	golden oak textured	dark walnut textured	gray oak textured***	elm tabac
	elm anthracite	wenge dark											
	*** decor available only in horizontal wood grain												
Decor 3D	grand oak	elm	walnut american	ebony	polish oak 3D								

STANDARD OPTION

- » stiles and rails made of MDF
- » glass pane MAT DRE 4 mm thick (SOLTE 2 - 3)
- » flat panel insert (SOLTE 1 - 2)

OPTION WITHOUT ADDITIONAL CHARGE

- » glass pane DECORMAT BROWN, DECORMAT GRAPHITE and transparent glass pane
- » holes for ventilation sleeves

OPTIONS AVAILABLE WITH EXTRA CHARGE

- » steel ventilation sleeves
- » plastic ventilation sleeves
- » non-rebated door leaf
- » door leaf „90” and „100”
- » ventilation undercut
- » cover-up strip for double leaf non-rebated door
- » double leaf door

REBATED DOOR LEAF

- » straight edge **fig. 1**
- » 3 silver screw-in pivot hinges
- » single-point mortise lock for simple key, for bathroom lock, for cylinder lock or economic lock

NON-REBATED DOOR LEAF (extra charge)

- » edge without rebate **fig. 2**
- » sockets for 3 hidden concealed W1078 hinges (non-rebated door frames are equipped with hinges)
- » magnetic lock for simple key, for bathroom lock, for cylinder lock or economic lock

SLIDING SYSTEM DOOR LEAF

- » edge without rebate **fig. 2**
- » socket for hook lock and/or for handles

NOTE: There is possibility to make rebated „40” side panels.
NOTE: It is required to use together with SOLTE door leaf model door frames equipped with 3 hinges.

fig. 1

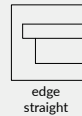
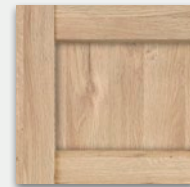

fig. 2



SOLTE panel





REVA 1 - vintage oak

Decor DRE-Cell	white (structure)	white mat	white pine	elm siberian	oak sand	bleached oak textured	ash	vintage oak	walnut caramel	golden oak textured	dark walnut textured	gray oak textured***	elm tabac
	elm anthracite	wenge dark											
Decor 3D	grand oak	elm	walnut american	ebony	polish oak 3D								

*** decor available only in horizontal wood grain

STANDARD OPTION

- » stiles and rails made of MDF
- » glass pane MAT DRE 4 mm thick

OPTION WITHOUT ADDITIONAL CHARGE

- » glass pane DECORMAT BROWN, DECORMAT GRAPHITE and transparent glass pane
- » holes for ventilation sleeves

OPTIONS AVAILABLE WITH EXTRA CHARGE

- » steel ventilation sleeves
- » plastic ventilation sleeves
- » non-rebated door leaf
- » door leaf „90” and „100”
- » ventilation undercut
- » cover-up strip for double leaf non-rebated door
- » double leaf door

REBATED DOOR LEAF

- » straight edge **fig. 1**
- » 3 silver screw-in pivot hinges
- » single-point mortise lock for simple key, for bathroom lock, for cylinder lock or economic lock

NON-REBATED DOOR LEAF (extra charge)

- » edge without rebate **fig. 2**
- » sockets for 3 hidden concealed W1078 hinges (non-rebated door frames are equipped with hinges)
- » magnetic lock for simple key, for bathroom lock, for cylinder lock or economic lock

SLIDING SYSTEM DOOR LEAF

- » edge without rebate **fig. 2**
- » socket for hook lock and/or for handles

NOTE: There is possibility to make rebated „40” side panels. It is required to use together with REVA door leaf model door frames equipped with 3 hinges.

fig. 1

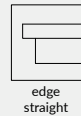

edge
straight

fig. 2



edge
without
rebate



REVA 1

REVA 2

REVA 3

REVA 4



NESTOR 3 white pine

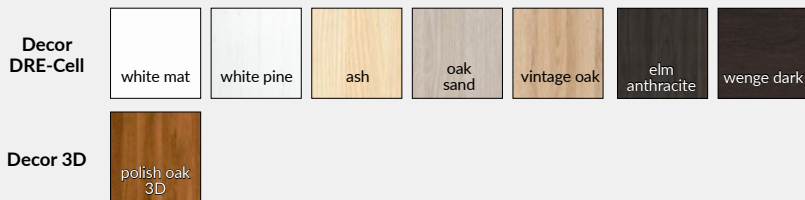

FREE MONDO DOOR HANDLE WITH BACKPLATE

(available only with rebated and non-rebated door leaf
in NESTOR and ELSA collections in DRE-CELL and 3D decor)
colour satin nickel



STANDARD OPTION

- » stiles and rails made of MDF
- » glass pane MAT DRE 4 mm thick
- » profiled 19mm MDF panels

OPTION WITHOUT ADDITIONAL CHARGE

- » glass pane DECORMAT BROWN, DECORMAT GRAPHITE and transparent glass pane
- » holes for ventilation sleeves

OPTIONS AVAILABLE WITH EXTRA CHARGE

- » steel ventilation sleeves
- » plastic ventilation sleeves
- » non-rebated door leaf
- » door leaf „90” and „100”
- » ventilation undercut
- » cover-up strip for double leaf non-rebated door
- » double leaf door

REBATED DOOR LEAF

- » straight edge **fig. 1**
- » 3 silver screw-in pivot hinges
- » single-point mortise lock for simple key, for bathroom lock, for cylinder lock or economic lock

NON-REBATED DOOR LEAF (EXTRA CHARGE)

- » edge without rebate **fig. 2**
- » sockets for 3 hidden concealed W1078 hinges (non-rebated door frames are equipped with hinges)
- » magnetic lock for simple key, for bathroom lock, for cylinder lock or economic lock

SLIDING SYSTEM DOOR LEAF

- » edge without rebate **fig. 2**
- » socket for hook lock and/or for handles

fig. 1

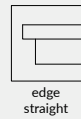

fig. 2



NOTE: It is required to use together with NESTOR door leaf model door frames equipped with 3 hinges.



panel
NESTOR



AURI white mat

Decor DRE-Cell	white (structure)	white mat	white pine	elm siberian	oak sand	bleached oak textured	ash	vintage oak	walnut caramel	golden oak textured	dark walnut textured	gray oak textured***	elm tabac
	elm anthracite	wenge dark											
Decor 3D	grand oak	elm	walnut american	ebony	polish oak 3D								

*** decor available only in horizontal wood grain

STANDARD OPTION

- » stiles and rails made of MDF
- » glass pane MAT DRE 4 mm thick

OPTION WITHOUT ADDITIONAL CHARGE

- » glass pane DECORMAT BROWN, DECORMAT GRAPHITE and transparent glass pane
- » holes for ventilation sleeves

OPTIONS AVAILABLE WITH EXTRA CHARGE

- » steel ventilation sleeves
- » plastic ventilation sleeves
- » non-rebated door leaf
- » door leaf „90” and „100”
- » ventilation undercut
- » cover-up strip for double leaf non-rebated door
- » double leaf door

REBATED DOOR LEAF

- » straight edge **fig. 1**
- » 3 silver screw-in pivot hinges
- » single-point mortise lock for simple key, for bathroom lock, for cylinder lock or economic lock

NON-REBATED DOOR LEAF (extra charge)

- » edge without rebate **fig. 2**
- » sockets for 3 hidden concealed W1078 hinges (non-rebated door frames are equipped with hinges)
- » magnetic lock for simple key, for bathroom lock, for cylinder lock or economic lock

SLIDING SYSTEM DOOR LEAF

- » edge without rebate **fig. 2**
- » socket for hook lock and/or for handles

fig. 1

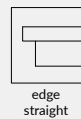

fig. 2



NOTE: There is possibility to make rebated „40” side panels. It is required to use together with AURI door leaf model door frames equipped with 3 hinges.





ELSA A2 and ELSA elm anthracite

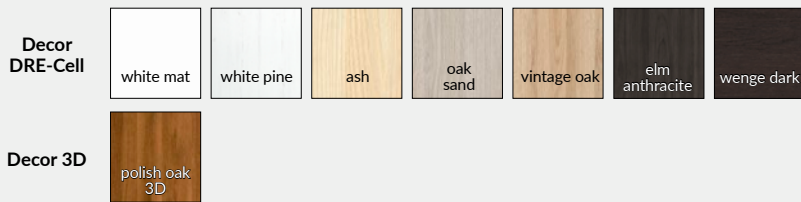

FREE MONDO DOOR HANDLE WITH BACKPLATE
 (available only with rebated and non-rebated door leaf
 in NESTOR and ELSA collections in DRE-CELL and 3D decor)
 colour satin nickel



STANDARD OPTION

- » stiles and rails made of MDF
- » glass pane MAT DRE 4 mm thick
- » flat panel insert (ELSA A), profiled 19 mm MDF panels (ELSA B)

OPTION WITHOUT ADDITIONAL CHARGE

- » glass pane DECORMAT BROWN, DECORMAT GRAPHITE and transparent glass pane
- » holes for ventilation sleeves

OPTIONS AVAILABLE WITH EXTRA CHARGE

- » steel ventilation sleeves
- » plastic ventilation sleeves
- » non-rebated door leaf
- » door leaf „90” and „100”
- » ventilation undercut
- » cover-up strip for double leaf non-rebated door
- » double leaf door

ELSA collection is divided into A and B:

A - flat panel insert in door leaf colour

B - 19 mm convex panel insert in door leaf colour

REBATED DOOR LEAF

- » straight edge **fig. 1**
- » 3 silver screw-in pivot hinges
- » single-point mortise lock for simple key, for bathroom lock, for cylinder lock or economic lock

NON-REBATED DOOR LEAF (extra charge)

- » edge without rebate **fig. 2**
- » sockets for 3 hidden concealed W1078 hinges (non-rebated door frames are equipped with hinges)
- » magnetic lock for simple key, for bathroom lock, for cylinder lock or economic lock

SLIDING SYSTEM DOOR LEAF

- » edge without rebate **fig. 2**
- » socket for hook lock and/or for handles

NOTE: There is possibility to make rebated „40” side panels. It is required to use together with ELSA door leaf model door frames equipped with 3 hinges.

fig. 1

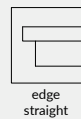

fig. 2



cross-section of ELSA A



cross-section of ELSA B

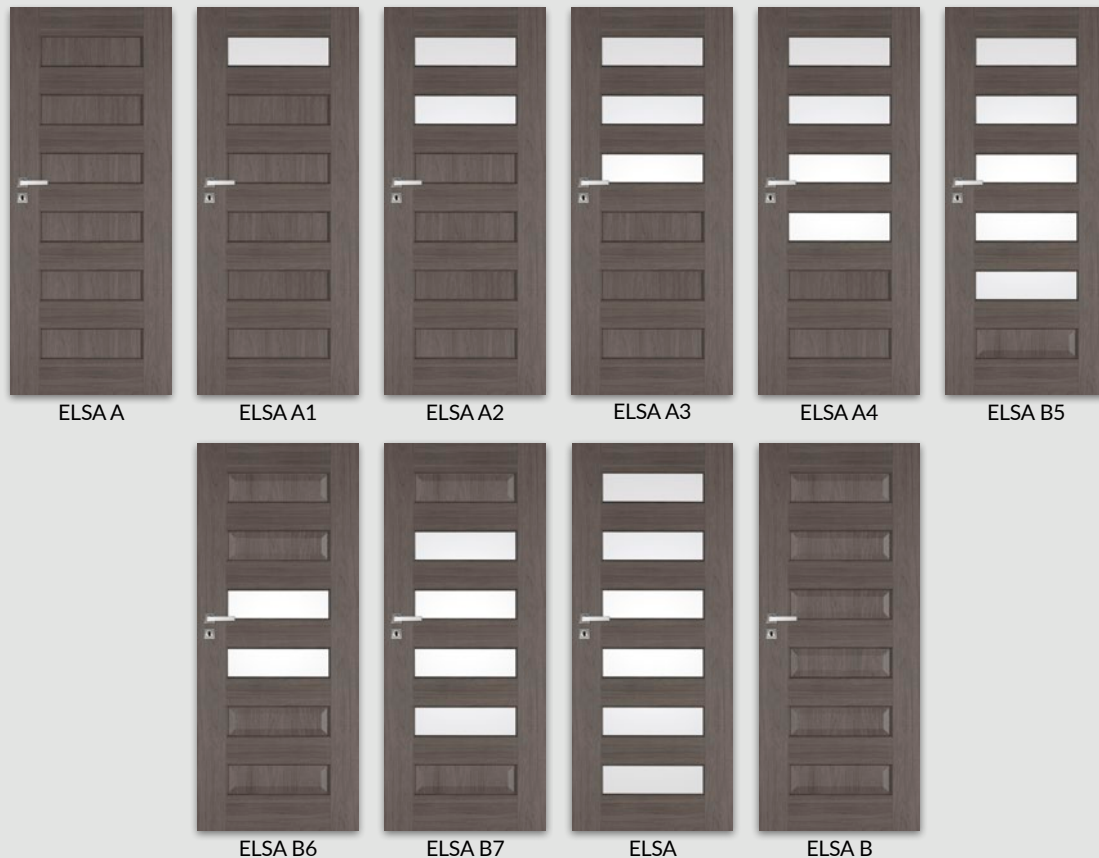

STANDARD OPTION

- » stiles and rails made of MDF
- » glass pane MAT DRE 4 mm thick
- » flat panel insert coated with silver laminate (FOSCA 1-3) or in door leaf colour (FOSCA 4-6)

OPTION WITHOUT ADDITIONAL CHARGE

- » glass pane DECORMAT BROWN, DECORMAT GRAPHITE and transparent glass pane
- » holes for ventilation sleeves

OPTIONS AVAILABLE WITH EXTRA CHARGE

- » steel ventilation sleeves
- » plastic ventilation sleeves
- » non-rebated door leaf
- » door leaf „90” and „100”
- » ventilation undercut
- » cover-up strip for double leaf non-rebated door
- » double leaf door

NOTE: There is possibility to make rebated „40” side panels. It is required to use together with FOSCA door leaf model door frames equipped with 3 hinges.

REBATED DOOR LEAF

- » straight edge **fig. 1**
- » 3 silver screw-in pivot hinges
- » single-point mortise lock for simple key, for bathroom lock, for cylinder lock or economic lock

NON-REBATED DOOR LEAF (extra charge)

- » edge without rebate **fig. 2**
- » sockets for 3 hidden concealed W1078 hinges (non-rebated door frames are equipped with hinges)
- » magnetic lock for simple key, for bathroom lock, for cylinder lock or economic lock

SLIDING SYSTEM DOOR LEAF

- » edge without rebate **fig. 2**
- » socket for hook lock and/or for handles

fig. 1



edge straight

fig. 2



edge without rebate

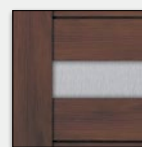

FOSCA 1-3
(4mm HDF insert coated with silver laminate)

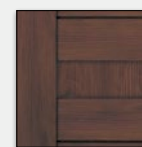

FOSCA 4-6
(4mm HDF insert coated in door leaf colour)

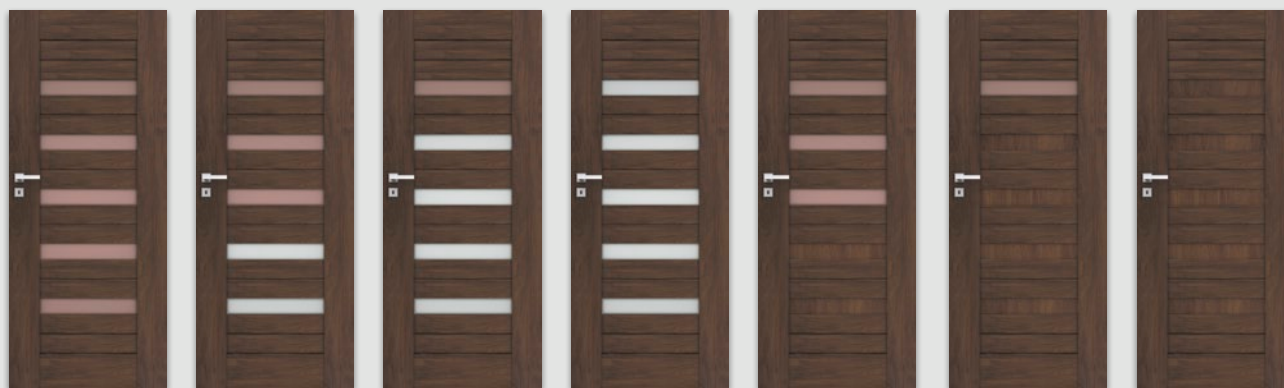

FOSCA
(5 glass panes)

FOSCA 1
(3 glass panes, 2 HDF panels)

FOSCA 2
(1 glass pane, 4 HDF panels)

FOSCA 3
(5 HDF panels)

FOSCA 4
(3 glass panes, 2 HDF panels)

FOSCA 5
(1 glass pane, 4 HDF panels)

FOSCA 6
(5 HDF panels)

Decor DRE-Cell

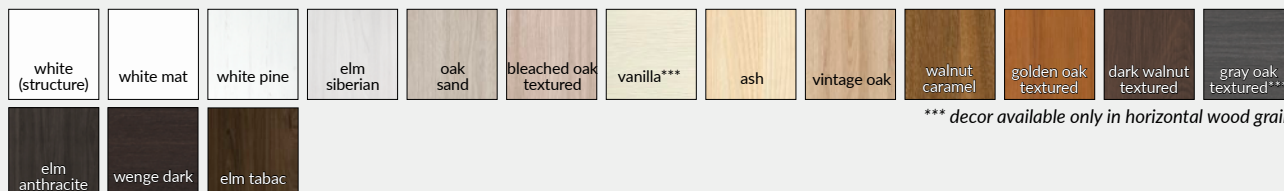

*** decor available only in horizontal wood grain

Decor 3D



STANDARD OPTION

- » stiles and rails made of MDF
- » glass pane MAT DRE 4 mm thick

OPTION WITHOUT ADDITIONAL CHARGE

- » glass pane DECORMAT BROWN, DECORMAT GRAPHITE and transparent glass pane
- » holes for ventilation sleeves

OPTIONS AVAILABLE WITH EXTRA CHARGE

- » steel ventilation sleeves
- » plastic ventilation sleeves
- » non-rebated door leaf
- » door leaf „90” and „100”
- » ventilation undercut
- » cover-up strip for double leaf non-rebated door
- » double leaf door

NOTE: There is possibility to make rebated „40” side panels. It is required to use together with PREMIUM door leaf model door frames equipped with 3 hinges.

REBATED DOOR LEAF

- » straight edge **fig. 1**
- » 3 silver screw-in pivot hinges
- » single-point mortise lock for simple key, for bathroom lock, for cylinder lock or economic lock

NON-REBATED DOOR LEAF (extra charge)

- » edge without rebate **fig. 2**
- » sockets for 3 hidden concealed W1078 hinges (non-rebated door frames are equipped with hinges)
- » magnetic lock for simple key, for bathroom lock, for cylinder lock or economic lock

SLIDING SYSTEM DOOR LEAF

- » edge without rebate **fig. 2**
- » socket for hook lock and/or for handles

fig. 1

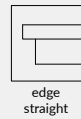

fig. 2



PREMIUM, PREMIUM 1-3
(4 mm glass pane)

*PREMIUM 4-7
(4 mm HDF inserts in door leaf colour)

**PREMIUM 8-11(4 mm HDF inserts coated with silver laminate)



PREMIUM
PREMIUM 4*
PREMIUM 8**

PREMIUM 1
PREMIUM 5*
PREMIUM 9**

PREMIUM 2
PREMIUM 6*
PREMIUM 10**

PREMIUM 3
PREMIUM 7*
PREMIUM 11**

white (structure)	white mat	white pine	elm siberian	oak sand	bleached oak textured	vanilla***	ash	vintage oak	walnut caramel	golden oak textured	dark walnut textured	gray oak textured***	Decor DRE-Cell			
											elm anthracite	wenge dark		elm tabac		
											grand oak	elm	walnut american	ebony	polish oak 3D	Decor 3D

*** decor available only in horizontal wood grain



PIANO - ebony

Decor DRE-Cell	white (structure)	white mat	white pine	elm siberian	oak sand	bleached oak textured	vanilla***	ash	vintage oak	walnut caramel	golden oak textured	dark walnut textured	gray oak textured***
	elm anthracite	wenge dark	elm tabac	*** decor available only in horizontal wood grain									
Decor 3D	grand oak	elm	walnut american	ebony	polish oak 3D								

STANDARD OPTION

- » stiles and rails made of MDF
- » glass pane MAT DRE 4 mm thick
- » 16 mm convex panel (PIANO 1-2, PIANO 5-6)
or 19 mm convex panel (PIANO 9-12)

OPTION WITHOUT ADDITIONAL CHARGE

- » glass pane DECORMAT BROWN, DECORMAT GRAPHITE and transparent glass pane
- » holes for ventilation sleeves

REBATED DOOR LEAF

- » straight edge **fig. 1**
- » 3 silver screw-in pivot hinges
- » single-point mortise lock for simple key, for bathroom lock, for cylinder lock or economic lock

NON-REBATED DOOR LEAF (extra charge)

- » edge without rebate **fig. 2**
- » sockets for 3 hidden concealed W1078 hinges (non-rebated door frames are equipped with hinges)
- » magnetic lock for simple key, for bathroom lock, for cylinder lock or economic lock

SLIDING SYSTEM DOOR LEAF

- » edge without rebate **fig. 2**
- » socket for hook lock and/or for handles

OPTIONS AVAILABLE WITH EXTRA CHARGE

- » steel ventilation sleeves
- » plastic ventilation sleeves
- » non-rebated door leaf
- » door leaf „90” and „100”
- » ventilation undercut
- » cover-up strip for double leaf non-rebated door
- » double leaf door

NOTE: There is possibility to make rebated „40” side panels. It is required to use together with PIANO door leaf model door frames equipped with 3 hinges.

fig. 1



edge straight

fig. 2



edge without rebate

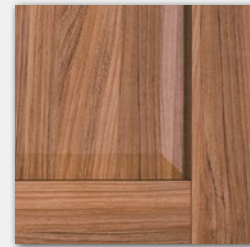

panel PIANO 9-12





SCALA - dark walnut textured

Decor DRE-Cell	white (structure)	white mat	white pine	elm siberian	oak sand	bleached oak textured	vanilla***	ash	vintage oak	walnut caramel	golden oak textured	dark walnut textured	gray oak textured***
	elm anthracite	wenge dark	elm tabac										
	*** decor available only in horizontal wood grain												
Decor 3D	grand oak	elm	walnut american	ebony	polish oak 3D								

FREE STYLISH DOOR HANDLE WITH BACKPLATE

(available only rebated and non-rebated door leaf in SCALA collection in DRE-Cell and 3D decor)
colour satin nickel



STANDARD OPTION

- » stiles and rails made of MDF
- » glass pane MAT DRE 4 mm thick
- » flat panel insert (SCALA A), 19 mm profiled MDF panels (SCALA B)

OPTION WITHOUT ADDITIONAL CHARGE

- » glass pane DECORMAT BROWN, DECORMAT GRAPHITE and transparent glass pane
- » holes for ventilation sleeves

OPTIONS AVAILABLE WITH EXTRA CHARGE

- » steel ventilation sleeves
- » plastic ventilation sleeves
- » non-rebated door leaf
- » door leaf „90” and „100”
- » ventilation undercut
- » cover-up strip for double leaf non-rebated door
- » double leaf door

SCALA collection is divided into A and B:
A - flat panel insert in door leaf colour
B - convex panel insert in door leaf colour

REBATED DOOR LEAF

- » straight edge **fig. 1**
- » 3 silver screw-in pivot hinges
- » single-point mortise lock for simple key, for bathroom lock, for cylinder lock or economic lock

NON-REBATED DOOR LEAF (extra charge)

- » edge without rebate **fig. 2**
- » sockets for 3 hidden concealed W1078 hinges (non-rebated door frames are equipped with hinges)
- » magnetic lock for simple key, for bathroom lock, for cylinder lock or economic lock

SLIDING SYSTEM DOOR LEAF

- » edge without rebate **fig. 2**
- » socket for hook lock and/or for handles

fig. 1

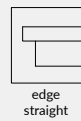
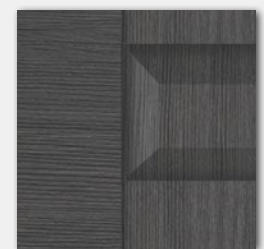

fig. 2



panel SCALA A, A1-A7



panel SCALA B, B1-B7

NOTE: There is possibility to make rebated „40” side panels.
It is required to use together with SCALA door leaf model door frames equipped with 3 hinges.





SINCO niagara

Finish
vener

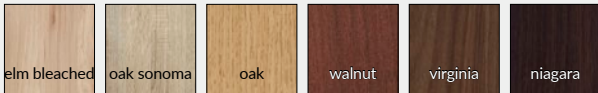

STANDARD OPTION

- » stiles and rails made of MDF
- » glass pane MAT DRE 4 mm thick
- » flat panels

OPTION WITHOUT ADDITIONAL CHARGE

- » holes for ventilation sleeves

OPTIONS AVAILABLE WITH EXTRA CHARGE

- » steel ventilation sleeves
- » plastic ventilation sleeves
- » door leaf „90” and „100”
- » ventilation undercut

NOTE: It is required to use together with SINCO door leaf model door frames equipped with 3 hinges.

REBATED DOOR LEAF

- » straight edge **fig. 1**
- » 3 silver screw-in pivot hinges
- » single-point mortise lock for simple key, for bathroom lock, for cylinder lock or economic lock

fig. 1

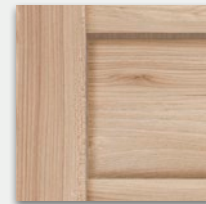
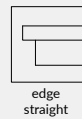

panel SINCO





VETRO A1 ebony

Decor DRE-Cell	white (structure)	white mat	white pine	elm siberian	oak sand	bleached oak textured	ash	vintage oak	walnut caramel	golden oak textured	dark walnut textured	gray oak textured***	elm tabac
	elm anthracite	wenge dark											
Decor 3D	grand oak	elm	walnut american	ebony	polish oak 3D								

*** decor available only in horizontal wood grain

NOTE: It is possible to order non-rebated door leaf in Dre-Cell white mat colour.

cross-section of stile in non-rebated door leaf

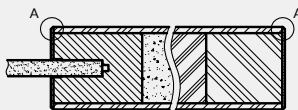

A - milled edges

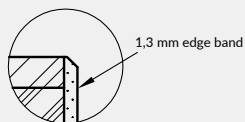

VETRO collection glass panes have obverse and reverse sides (important in juxtaposition of doors opening inversely). Presented horizontal cross-sections shows the arrangement of glass pane in the obverse version. When choosing a reverse version, glass pane is rotated by 180° around the vertical axis.

Horizontal cross-section of door leaf VETRO A1-A4, A12-A15

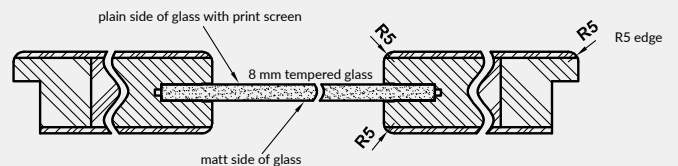

Horizontal cross-section of door leaf VETRO A5, A10 - A11

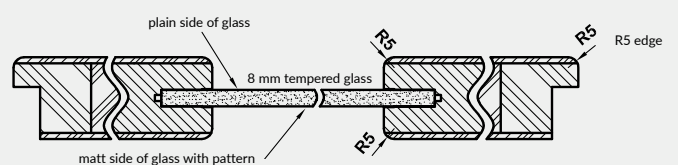

STANDARD OPTION

- » frame made of MDF additionally reinforced with plywood
- » core made of perforated chipboard
- » 8 mm tempered glass

OPTION WITHOUT ADDITIONAL CHARGE

- » there is possibility to make ventilation undercut (A)
- » door leaf with revers positioning of glass pane
- » VETRO A1 four possible types of glass pane: DECORMAT, DECORMAT BROWN, DECORMAT GRAPHITE and transparent glass

REBATED DOOR LEAF

- » R5 edge **fig. 1**
- » 3 silver screw-in pivot hinges
- » single-point mortise lock for simple key, for bathroom lock, for cylinder lock or economic lock

NON- REBATED DOOR LEAF (EXTRA CHARGE 55 PLN)

ONLY WHITE MAT

- » edge without rebate **fig. 2**
- » sockets for 3 hidden concealed W1078 hinges (non-rebated door frames are equipped with hinges)
- » magnetic lock for simple key, for bathroom lock, for cylinder lock or economic lock

OPTIONS AVAILABLE WITH EXTRA CHARGE - AVAILABLE ONLY IN WHITE MAT DRE- CELL DECOR

- » non-rebated door leaf

ventilation undercut (A)

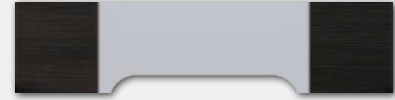

SLIDING SYSTEM DOOR LEAF

- » edge without rebate **fig. 2**
- » socket for hook lock and/or for handles

NOTE: There is no possibility to shorten door leaf. It is required to use together with VETRO door leaf model door frames equipped with 3 hinges. VETRO A - „80“-„100“ - with ventilation undercut fulfill ventilation requirements.

fig. 1



edge
R5

fig. 2



edge
without
rebate

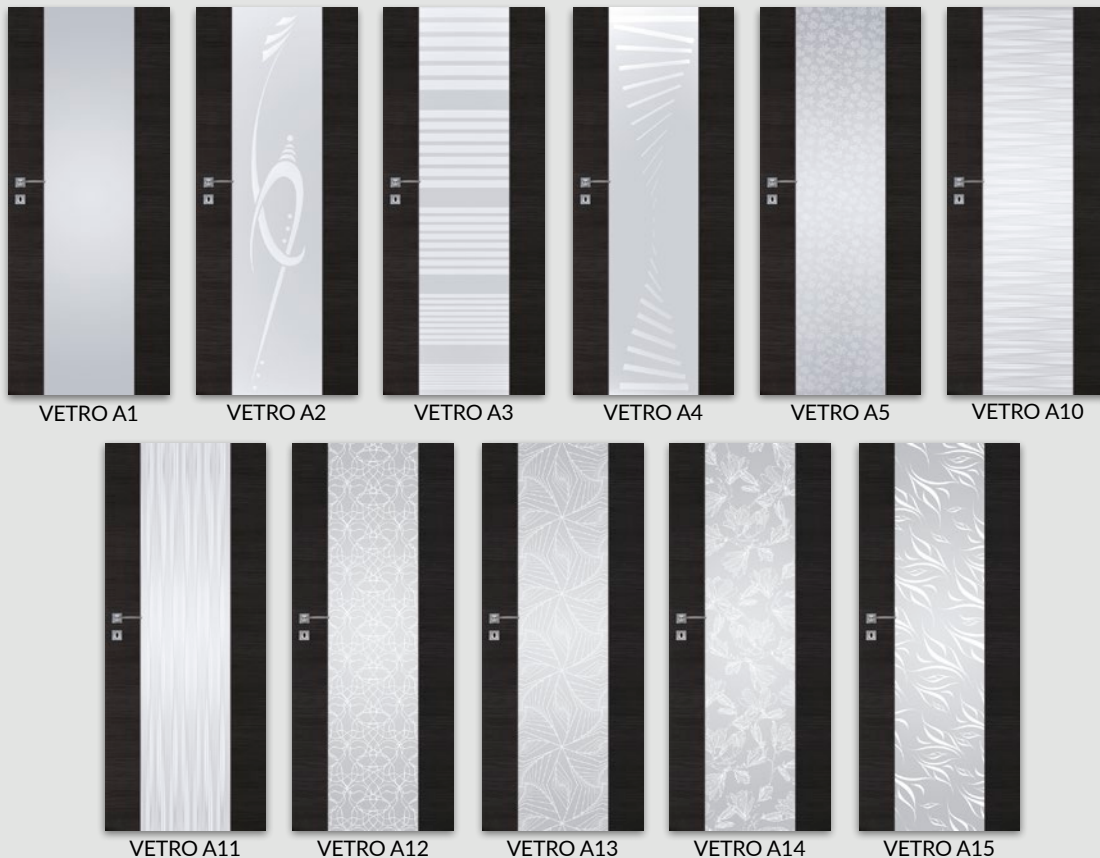



VETRO B1 - ebony

Decor DRE-Cell	white (structure)	white mat	white pine	elm siberian	oak sand	bleached oak textured	ash	vintage oak	walnut caramel	golden oak textured	dark walnut textured	gray oak textured***
	elm tabac	elm anthracite	wenge dark									
	Decor 3D	grand oak	elm	walnut american	ebony	polish oak 3D						

*** decor available only in horizontal wood grain

NOTE: It is possible to order non-rebated door leaf in Dre-Cell white mat colour.

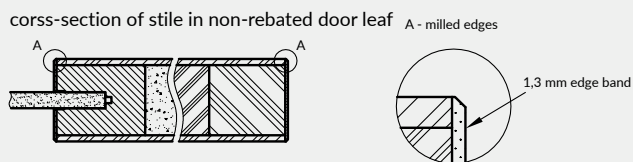

VETRO collection glass panes have obverse and reverse sides (important in juxtaposition of doors opening inversely). Presented horizontal cross-sections shows the arrangement of glass pane in the obverse version. When choosing a reverse version, glass pane is rotated by 180° around the vertical axis.

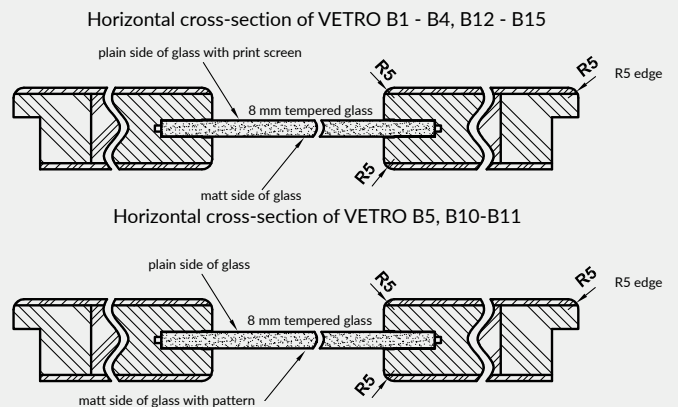

STANDARD OPTION

- » frame made of MDF additionally reinforced with plywood
- » core made of perforated chipboard
- » 8 mm tempered glass

OPTION WITHOUT ADDITIONAL CHARGE

- » there is possibility to make ventilation undercut (B)
- » VETRO B1 four possible types of glass pane: DECORMAT, DECORMAT BROWN, DECORMAT GRAPHITE and transparent glass
- » door leaf with revers positioning of glass pane

OPTIONS AVAILABLE WITH EXTRA CHARGE - AVAILABLE ONLY IN WHITE MAT DRE- CELL DECOR

- » non-rebated door leaf

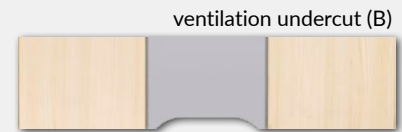

VETRO B - doesn't fulfill ventilation requirements

REBATED DOOR LEAF

- » R5 edge **fig. 1**
- » 3 silver screw-in pivot hinges
- » single-point mortise lock for simple key, for bathroom lock, for cylinder lock or economic lock

NON- REBATED DOOR LEAF (EXTRA CHARGE 55 PLN)

ONLY WHITE MAT

- » edge without rebate **fig. 2**
- » sockets for 3 hidden concealed W1078 hinges (non-rebated door frames are equipped with hinges)
- » magnetic lock for simple key, for bathroom lock, for cylinder lock or economic lock

SLIDING SYSTEM DOOR LEAF

- » edge without rebate **fig. 2**
- » socket for hook lock and/or for handles

NOTE: There is no possibility to shorten door leaf. It is required to use together with VETRO door leaf model door frames equipped with 3 hinges. VETRO B - doesn't fulfill ventilation requirements.

fig. 1



edge R5

fig. 2



edge without rebate

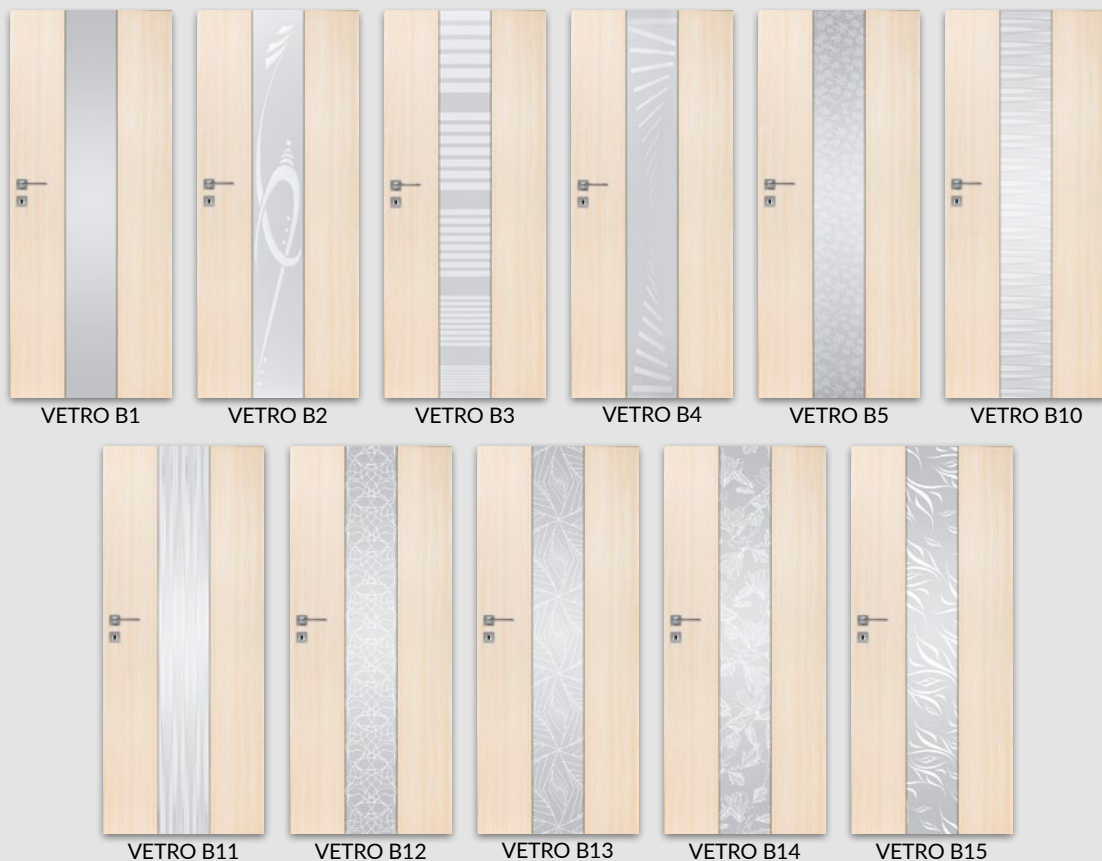



VETRO C1 decormat dark walnut textured

Decor
DRE-Cell

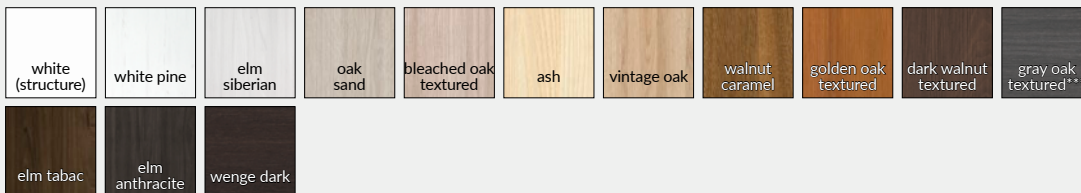

*** decor available only in horizontal wood grain

VETRO collection glass panes have obverse and reverse sides (important in juxtaposition of doors opening inversely). Presented horizontal cross-sections shows the arrangement of glass pane in the obverse version. When choosing a reverse version, glass pane is rotated by 180° around the vertical axis.

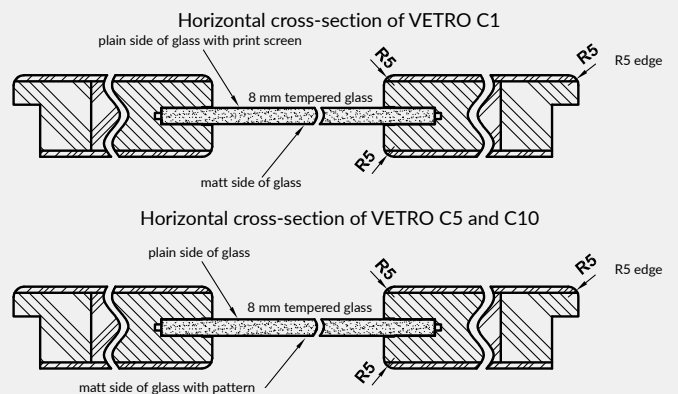

STANDARD OPTION

- » frame with fixed width made of MDF additionally reinforced with plywood
- » core made of perforated chipboard
- » 8 mm tempered glass with different width, dependent on width of the door leaf

OPTION WITHOUT ADDITIONAL CHARGE

- » there is possibility to make ventilation undercut (C)
- » door leaf with revers positioning of glass pane

ventilation undercut (C)

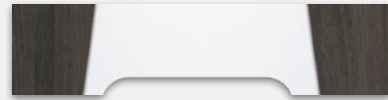

REBATED DOOR LEAF

- » R5 edge **fig. 1**
- » 3 silver screw-in pivot hinges
- » single-point mortise lock for simple key, for bathroom lock, for cylinder lock or economic lock

NOTE: There is no possibility to shorten door leaf.
It is required to use together with VETRO door leaf model door frames equipped with 3 hinges.
VETRO C - „80“-„100“ - with ventilation undercut fulfill ventilation requirements.

fig. 1

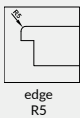



VETRO D1 - elm anthracite

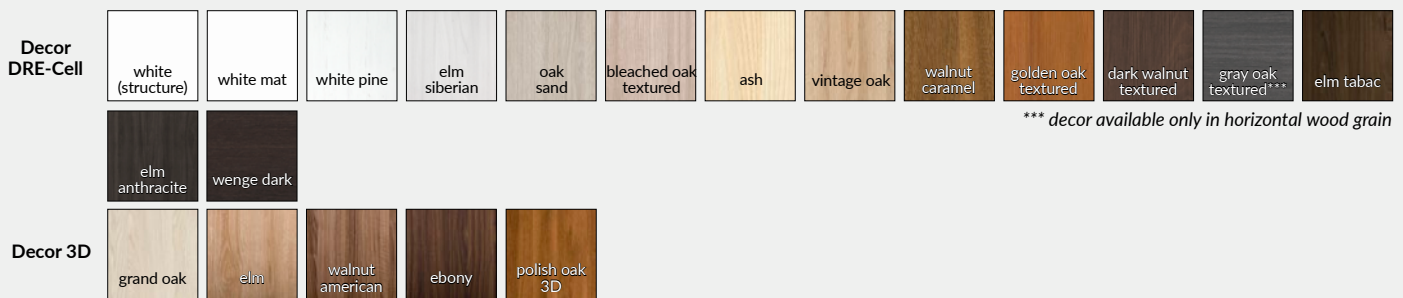

NOTE: It is possible to order non-rebated door leaf in Dre-Cell white mat colour.

VETRO collection glass panes have obverse and reverse sides (important in juxtaposition of doors opening inversely). Presented horizontal cross-sections shows the arrangement of glass pane in the obverse version. When choosing a reverse version, glass pane is rotated by 180° around the vertical axis.

cross-section of stile in non-rebated door leaf

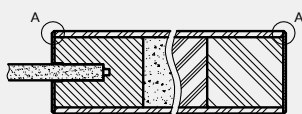

A - milled edges

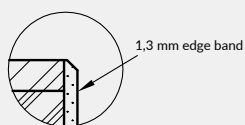

Horizontal cross-section of VETRO D1

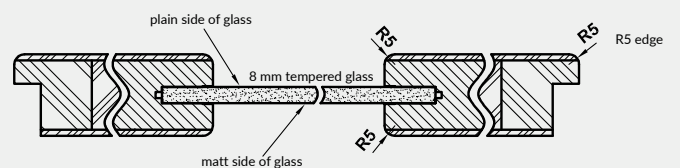

STANDARD OPTION

- » frame made of MDF additionally reinforced with plywood: narrow element with fixed width, wide element with different width
- » core made of perforated chipboard
- » 8 mm tempered glass with fixed width, (regardless of the door leaf width)

OPTION WITHOUT ADDITIONAL CHARGE

- » door leaf with revers positioning of glass pane

REBATED DOOR LEAF

- » R5 edge **fig. 1**
- » 3 silver screw-in pivot hinges
- » single-point mortise lock for simple key, for bathroom lock, for cylinder lock or economic lock

NON- REBATED DOOR LEAF (EXTRA CHARGE 55 PLN)

ONLY WHITE MAT

- » edge without rebate **fig. 2**
- » sockets for 3 hidden concealed W1078 hinges (non-rebated door frames are equipped with hinges)
- » magnetic lock for simple key, for bathroom lock, for cylinder lock or economic lock

OPTIONS AVAILABLE WITH EXTRA CHARGE - AVAILABLE ONLY IN WHITE MAT DRE- CELL DECOR

- » non-rebated door leaf

SLIDING SYSTEM DOOR LEAF

- » edge without rebate **fig. 2**
- » socket for hook lock and/or for handles

NOTE: There is no possibility to shorten door leaf. There is no possibility to make ventilation undercut. VETRO D - doesn't fulfill ventilation requirements. It is required to use together with VETRO door leaf model door frames equipped with 3 hinges.

fig. 1



edge
R5

fig. 2



edge
without
rebate



VETRO D1
glass pane
transparent

VETRO D1
decormat

VETRO D1
decormat brown

VETRO D1
decormat
graphite



VETRO natura A13 - bleached oak

vener
natural



VETRO collection glass panes have obverse and reverse sides (important in juxtaposition of doors opening inversely). Presented horizontal cross-sections shows the arrangement of glass pane in the obverse version. When choosing a reverse version, glass pane is rotated by 180° around the vertical axis.

Horizontal cross-section of door leaf VETRO A1-A4, A12-A15

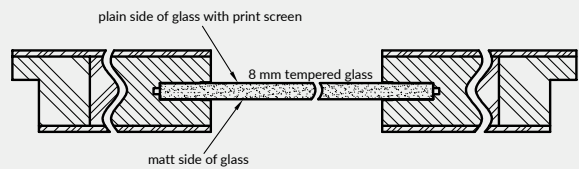

Horizontal cross-section of door leaf VETRO A5, A10 - A11

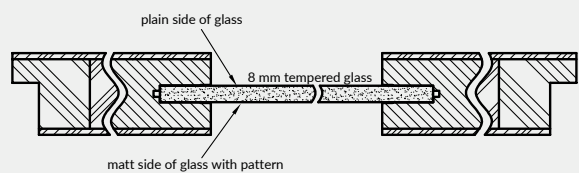

STANDARD OPTION

- » frame made of MDF additionally reinforced with plywood
- » core made of perforated chipboard
- » 8 mm tempered glass
- » natural veneer

OPTION WITHOUT ADDITIONAL CHARGE

- » there is possibility to make ventilation undercut (A)
- » door leaf with revers positioning of glass pane
- » VETRO A1 four possible types of glass pane: DECORMAT, DECORMAT BROWN, DECORMAT GRAPHITE and transparent glass

REBATED DOOR LEAF

- » straight edge **fig. 1**
- » 3 silver screw-in pivot hinges
- » single-point mortise lock for simple key, for bathroom lock, for cylinder lock or economic lock

SLIDING SYSTEM DOOR LEAF

- » edge without rebate **fig. 2**
- » socket for hook lock and/or for handles

NOTE: There is no possibility to shorten door leaf. It is required to use together with VETRO door leaf model door frames equipped with 3 hinges.

VETRO A - „80“-„100“ - with ventilation undercut fulfill ventilation requirements.

NOTE: The specificity of natural veneer is a possibility of differences in wood grain and staining. These differences can not be the basis of the accepted complaint.

fig. 1

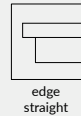
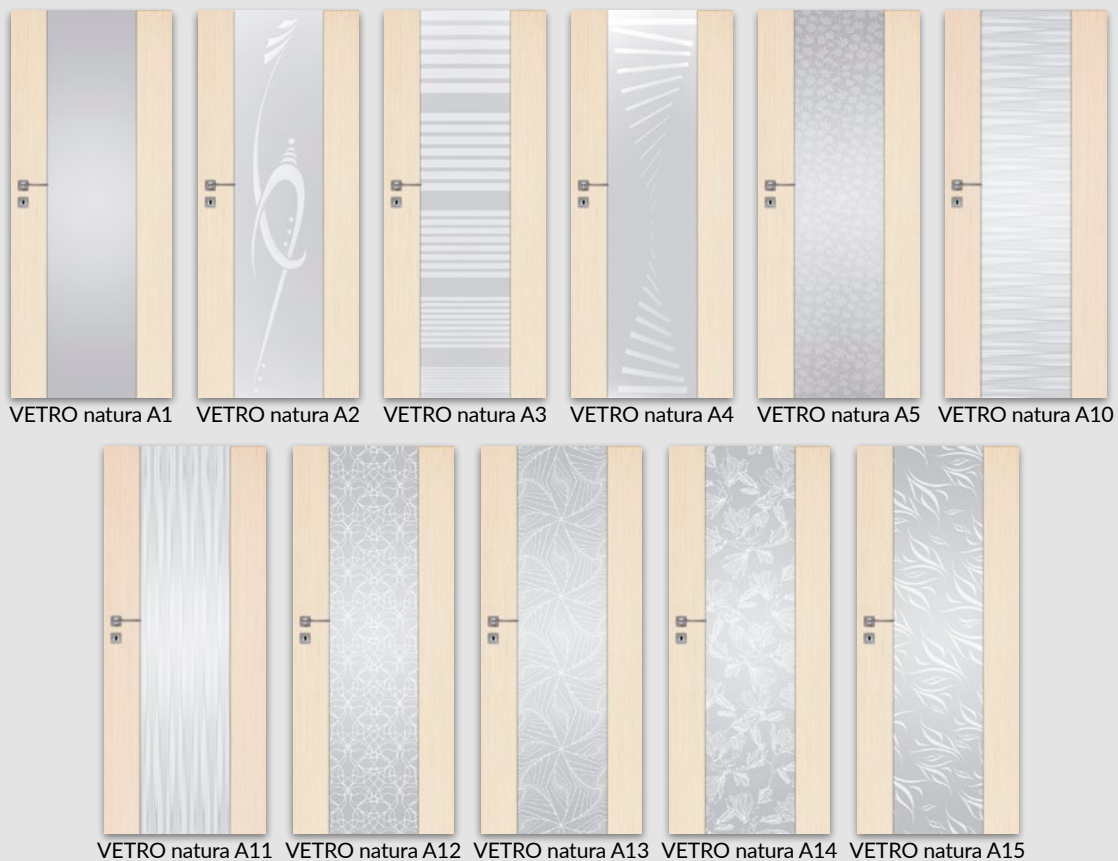

fig. 2





VETRO natura B15 - dark walnut

vener
natural

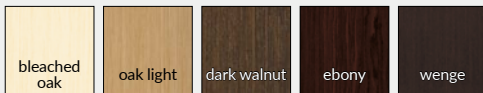

Horizontal cross-section of B1-B4, B12-B15

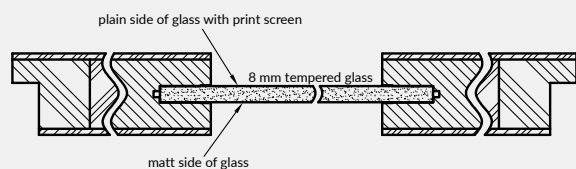

Horizontal cross-section of VETRO B5, B10-B11

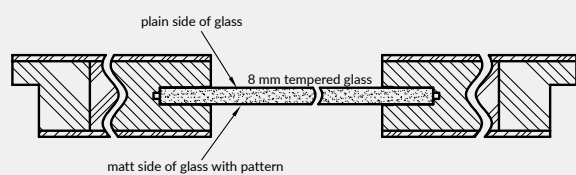

VETRO collection glass panes have obverse and reverse sides (important in juxtaposition of doors opening inversely). Presented horizontal cross-sections show the arrangement of glass pane in the obverse version. When choosing a reverse version, glass pane is rotated by 180° around the vertical axis.

STANDARD OPTION

- » frame made of MDF additionally reinforced with plywood
- » core made of perforated chipboard
- » 8 mm tempered glass
- » natural veneer

OPTION WITHOUT ADDITIONAL CHARGE

- » there is possibility to make ventilation undercut
- » door leaf with revers positioning of glass pane
- » VETRO B1 four possible types of glass pane: DECORMAT, DECORMAT BROWN, DECORMAT GRAPHITE and transparent glass

REBATED DOOR LEAF

- » straight edge **fig. 1**
- » 3 silver screw-in pivot hinges
- » single-point mortise lock for simple key, for bathroom lock, for cylinder lock or economic lock

SLIDING SYSTEM DOOR LEAF

- » edge without rebate **fig. 2**
- » socket for hook lock and/or for handles

NOTE: There is no possibility to shorten door leaf. It is required to use together with VETRO door leaf model door frames equipped with 3 hinges.

VETRO B - doesn't fulfill ventilation requirements.

NOTE: The specificity of natural veneer is a possibility of differences in wood grain and staining. These differences can not be the basis of the accepted complaint.

fig. 1

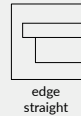
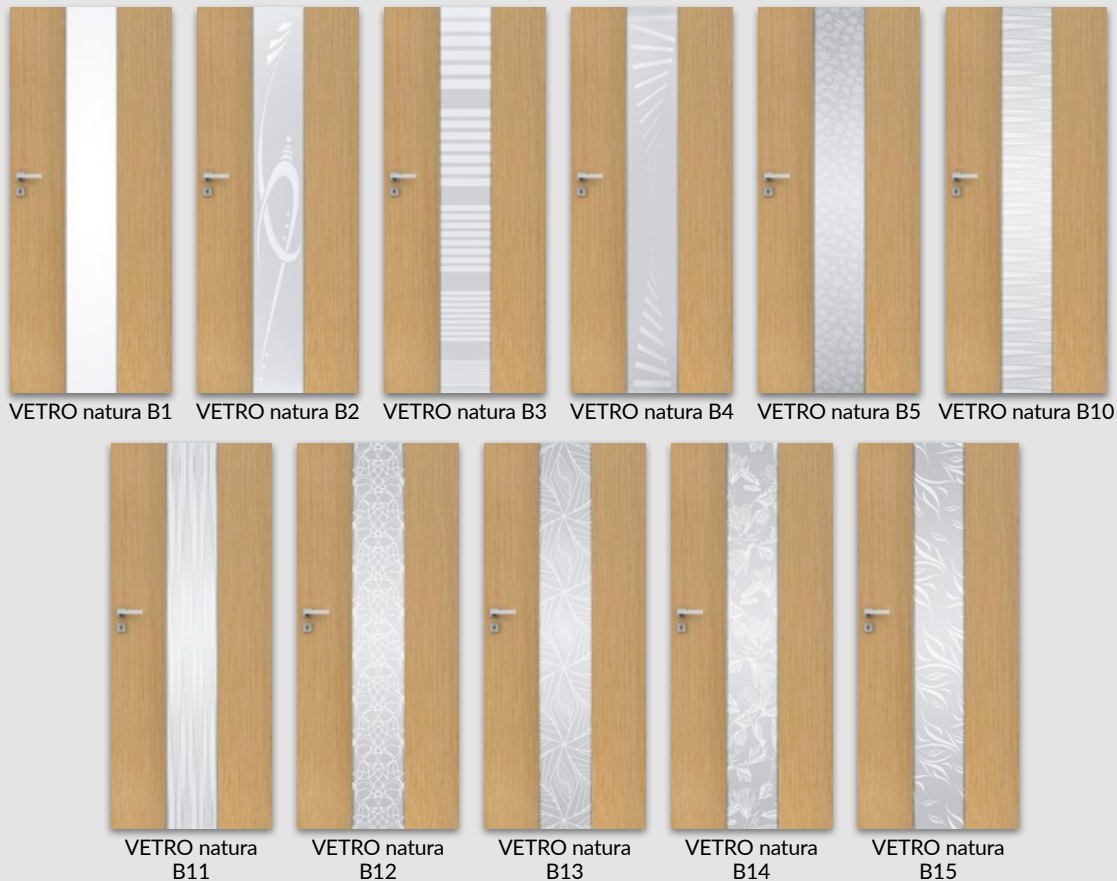

fig. 2



PREMIUM NATURA

REBATED AND NON-REBATED DOOR LEAF
interior door leaf



STANDARD OPTION

- » stiles and rails made of MDF
- » glass pane MAT DRE 4 mm thick
- » natural veneer

OPTION WITHOUT ADDITIONAL CHARGE

- » glass pane DECORMAT BROWN, DECORMAT GRAPHITE and transparent glass pane
- » holes for ventilation sleeves

OPTIONS AVAILABLE WITH EXTRA CHARGE

- » steel ventilation sleeves
- » non-rebated door leaf
- » door leaf „90” and „100”
- » ventilation undercut
- » cover-up strip for double leaf non-rebated door
- » double leaf door

NOTE: There is possibility to make rebated „40” side panels. It is required to use together with PREMIUM door leaf model door frames equipped with 3 hinges.

NOTE: The specificity of natural veneer is a possibility of differences in wood grain and staining. These differences can not be the basis of the accepted complaint.

REBATED DOOR LEAF

- » straight edge **fig. 1**
- » 3 silver screw-in pivot hinges
- » single-point mortise lock for simple key, for bathroom lock, for cylinder lock or economic lock

NON-REBATED DOOR LEAF (extra charge)

- » edge without rebate **fig. 2**
- » sockets for 3 hidden concealed W1078 hinges (non-rebated door frames are equipped with hinges)
- » magnetic lock for simple key, for bathroom lock, for cylinder lock or economic lock

SLIDING SYSTEM DOOR LEAF

- » edge without rebate **fig. 2**
- » socket for hook lock and/or for handles

fig. 1



edge
straight

fig. 2



edge
without
rebate



PREMIUM natura PREMIUM 1 natura PREMIUM 2 natura PREMIUM 3 natura

veneer
natural

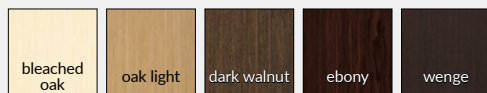

STANDARD OPTION

- » stiles and rails made of MDF
- » glass pane MAT DRE 4 mm thick
- » natural veneer

OPTION WITHOUT ADDITIONAL CHARGE

- » glass pane DECORMAT BROWN, DECORMAT GRAPHITE and transparent glass pane
- » holes for ventilation sleeves

REBATED DOOR LEAF

- » straight edge **fig. 1**
- » 3 silver screw-in pivot hinges
- » single-point mortise lock for simple key, for bathroom lock, for cylinder lock or economic lock

NON-REBATED DOOR LEAF (extra charge)

- » edge without rebate **fig. 2**
- » sockets for 3 hidden concealed W1078 hinges (non-rebated door frames are equipped with hinges)
- » magnetic lock for simple key, for bathroom lock, for cylinder lock or economic lock

SLIDING SYSTEM DOOR LEAF

- » edge without rebate **fig. 2**
- » socket for hook lock and/or for handles

OPTIONS AVAILABLE WITH EXTRA CHARGE

- » steel ventilation sleeves
- » non-rebated door leaf
- » door leaf „90” and „100”
- » ventilation undercut
- » cover-up strip for double leaf non-rebated door
- » double leaf door

NOTE: There is possibility to make rebated „40” side panels. It is required to use together with DOVA door leaf model door frames equipped with 3 hinges.

NOTE: The specificity of natural veneer is a possibility of differences in wood grain and staining. These differences can not be the basis of the accepted complaint.

fig. 1

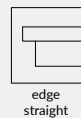
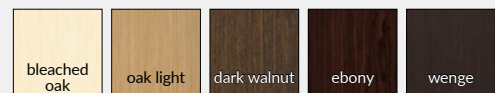

fig. 2



veneer natural

STANDARD OPTION

- » stiles and rails made of MDF
- » glass pane MAT DRE 4 mm thick
- » natural veneer
- » flat panels

OPTION WITHOUT ADDITIONAL CHARGE

- » glass pane DECORMAT BROWN, DECORMAT GRAPHITE and transparent glass pane
- » holes for ventilation sleeves

REBATED DOOR LEAF

- » straight edge **fig. 1**
- » 3 silver screw-in pivot hinges
- » single-point mortise lock for simple key, for bathroom lock, for cylinder lock or economic lock

NON-REBATED DOOR LEAF (extra charge)

- » edge without rebate **fig. 2**
- » sockets for 3 hidden concealed W1078 hinges (non-rebated door frames are equipped with hinges)
- » magnetic lock for simple key, for bathroom lock, for cylinder lock or economic lock

SLIDING SYSTEM DOOR LEAF

- » edge without rebate **fig. 2**
- » socket for hook lock and/or for handles

OPTIONS AVAILABLE WITH EXTRA CHARGE

- » steel ventilation sleeves
- » non-rebated door leaf
- » door leaf „90” and „100”
- » ventilation undercut
- » cover-up strip for double leaf non-rebated door
- » double leaf door

NOTE: There is possibility to make rebated „40” side panels. It is required to use together with SCALA door leaf model door frames equipped with 3 hinges.

NOTE: The specificity of natural veneer is a possibility of differences in wood grain and staining. These differences can not be the basis of the accepted complaint.

NOTE: Door handle and backplate must be purchased separately.

fig. 1



fig. 2

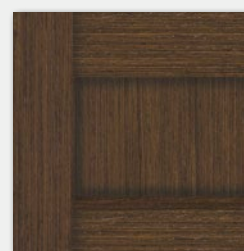
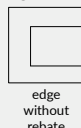

panel SCALA A natura

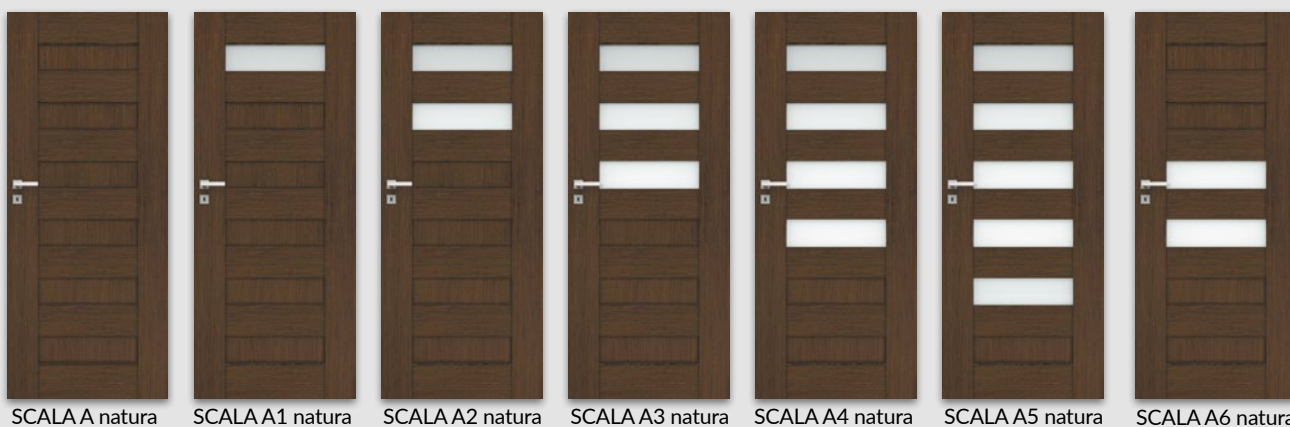

veneer natural

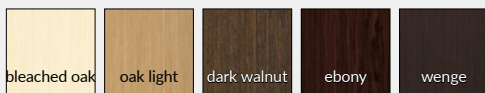

STANDARD OPTION

- » door leaf painted with water-based UV varnish
- » stiles and rails made of MDF
- » glass pane MAT DRE 4 mm thick
- » profiled 19mm MDF panels

OPTION WITHOUT ADDITIONAL CHARGE

- » glass pane DECORMAT BROWN, DECORMAT GRAPHITE and transparent glass pane
- » holes for ventilation sleeves

REBATED DOOR LEAF

- » straight edge **fig. 1**
- » 3 silver screw-in pivot hinges
- » single-point mortise lock for simple key, for bathroom lock, for cylinder lock or economic lock

NON-REBATED DOOR LEAF (extra charge)

- » edge without rebate **fig. 2**
- » sockets for 3 hidden concealed W1078 hinges (non-rebated door frames are equipped with hinges)
- » magnetic lock for simple key, for bathroom lock, for cylinder lock or economic lock

SLIDING SYSTEM DOOR LEAF

- » edge without rebate **fig. 2**
- » socket for hook lock and/or for handles

It is required to use together with LEXA door leaf model door frames equipped with 3 hinges.
To ensure the highest quality of painted products, before painting process, both, door leaf and door frames are coated with special material which constitutes solid base.

OPTIONS AVAILABLE WITH EXTRA CHARGE

- » steel ventilation sleeves
- » plastic ventilation sleeves
- » non-rebated door leaf
- » door leaf „90” and „100”
- » ventilation undercut
- » cover-up strip for double leaf non-rebated door
- » double leaf door

fig. 1



edge straight

fig. 2



edge without rebate



panel LEXA



LEXA A

LEXA A1

LEXA A2

LEXA A3

LEXA

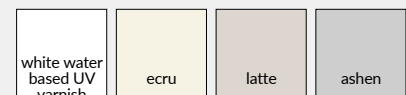

Decor

white water based UV varnish - RAL 9003
ecru - RAL 9001
latte - Flügger 4362, NCS S1505-Y50R
ashen - RAL 7035

STANDARD OPTION

- » door leaf painted with water-based UV varnish
- » stiles and rails made of MDF
- » glass pane MAT DRE 4 mm thick

OPTION WITHOUT ADDITIONAL CHARGE

- » glass pane DECORMAT BROWN, DECORMAT GRAPHITE and transparent glass pane
- » holes for ventilation sleeves

REBATED DOOR LEAF

- » straight edge **fig. 1**
- » 3 silver screw-in pivot hinges
- » single-point mortise lock for simple key, for bathroom lock, for cylinder lock or economic lock

NON-REBATED DOOR LEAF (extra charge)

- » edge without rebate **fig. 2**
- » sockets for 3 hidden concealed W1078 hinges (non-rebated door frames are equipped with hinges)
- » magnetic lock for simple key, for bathroom lock, for cylinder lock or economic lock

SLIDING SYSTEM DOOR LEAF

- » edge without rebate **fig. 2**
- » socket for hook lock and/or for handles

OPTIONS AVAILABLE WITH EXTRA CHARGE

- » steel ventilation sleeves
- » plastic ventilation sleeves
- » non-rebated door leaf
- » door leaf „90” and „100”
- » ventilation undercut
- » cover-up strip for double leaf non-rebated door
- » double leaf door

fig. 1



edge
straight

fig. 2



edge
without
rebate

NOTE: It is required to use together with EVEN door leaf model door frames equipped with 3 hinges.

To ensure the highest quality of painted products, before painting process, both, door leaf and door frames are coated with special material which constitutes solid base.

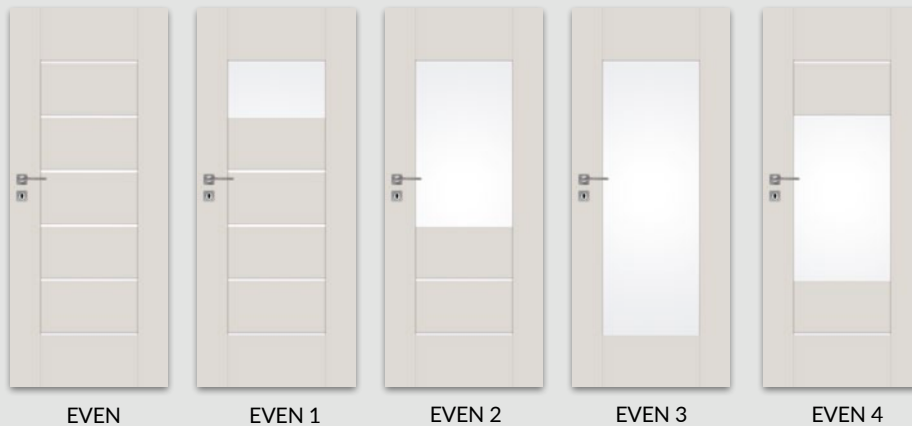

Decor



white water based UV varnish - RAL 9003
ecru - RAL 9001
latte - Flügger 4362, NCS S1505-Y50R
ashen - RAL 7035

STANDARD OPTION

- » door leaf painted with water-based UV varnish
- » stiles and rails made of MDF
- » glass pane MAT DRE 4 mm thick
- » profiled 19mm MDF panels

OPTION WITHOUT ADDITIONAL CHARGE

- » glass pane DECORMAT BROWN, DECORMAT GRAPHITE and transparent glass pane
- » holes for ventilation sleeves

REBATED DOOR LEAF

- » straight edge **fig. 1**
- » 3 silver screw-in pivot hinges
- » single-point mortise lock for simple key, for bathroom lock, for cylinder lock or economic lock

NON-REBATED DOOR LEAF (extra charge)

- » edge without rebate **fig. 2**
- » sockets for 3 hidden concealed W1078 hinges (non-rebated door frames are equipped with hinges)
- » magnetic lock for simple key, for bathroom lock, for cylinder lock or economic lock

SLIDING SYSTEM DOOR LEAF

- » edge without rebate **fig. 2**
- » socket for hook lock and/or for handles

OPTIONS AVAILABLE WITH EXTRA CHARGE

- » steel ventilation sleeves
- » plastic ventilation sleeves
- » non-rebated door leaf
- » door leaf „90” and „100”
- » ventilation undercut
- » cover-up strip for double leaf non-rebated door
- » double leaf door

fig. 1



edge straight

fig. 2



edge without rebate

NOTE: It is required to use together with NESTOR door leaf model door frames equipped with 3 hinges.

To ensure the highest quality of painted products, before painting process, both, door leaf and door frames are coated with special material which constitutes solid base.



Decor



white water based UV varnish - RAL 9003
ecru - RAL 9001
latte - Flugger 4362, NCS S1505-Y50R
ashen - RAL 7035



panel
NESTOR



TIXA - welsh oak

Laminate
CPL



STANDARD OPTION

- » rails made of softwood and MDF board
- » glass pane MAT DRE 4 mm thick

OPTION WITHOUT ADDITIONAL CHARGE

- » glass pane DECORMAT BROWN, DECORMAT GRAPHITE and transparent glass pane
- » holes for ventilation sleeves

REBATED DOOR LEAF

- » straight edge **fig. 1**
- » 3 silver screw-in pivot hinges
- » single-point mortise lock for simple key, for bathroom lock, for cylinder lock or economic lock

NON-REBATED DOOR LEAF (extra charge)

- » edge without rebate **fig. 2**
- » sockets for 3 hidden concealed W1078 hinges (non-rebated door frames are equipped with hinges)
- » magnetic lock for simple key, for bathroom lock, for cylinder lock or economic lock

NOTE: It is required to use together with TIXA door leaf model door frames equipped with 3 hinges.

OPTIONS AVAILABLE WITH EXTRA CHARGE

- » steel ventilation sleeves
- » non-rebated door leaf
- » door leaf „90” and „100”
- » ventilation undercut
- » cover-up strip for double leaf non-rebated door
- » double leaf door

fig. 1

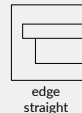

edge straight

fig. 2

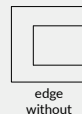

edge without rebate

CROSS-SECTION OF VERTICAL STILE

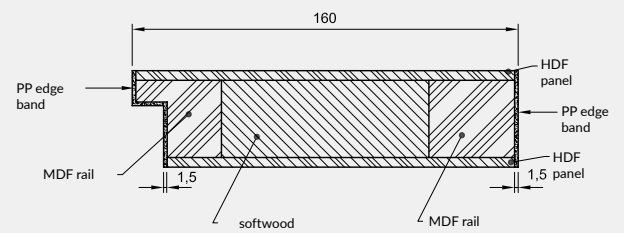



TIZANO 1 - welsh oak

Laminate
CPL



STANDARD OPTION

- » rails made of softwood and MDF board
- » glass pane MAT DRE 4 mm thick

OPTION WITHOUT ADDITIONAL CHARGE

- » glass pane DECORMAT BROWN, DECORMAT GRAPHITE and transparent glass pane
- » holes for ventilation sleeves

OPTIONS AVAILABLE WITH EXTRA CHARGE

- » steel ventilation sleeves
- » non-rebated door leaf
- » door leaf „90” and „100”
- » ventilation undercut
- » cover-up strip for double leaf non-rebated door
- » double leaf door

REBATED DOOR LEAF

- » straight edge **fig. 1**
- » 3 silver screw-in pivot hinges
- » single-point mortise lock for simple key, for bathroom lock, for cylinder lock or economic lock

NON-REBATED DOOR LEAF (extra charge)

- » edge without rebate **fig. 2**
- » sockets for 3 hidden concealed W1078 hinges (non-rebated door frames are equipped with hinges)
- » magnetic lock for simple key, for bathroom lock, for cylinder lock or economic lock

NOTE: It is required to use together with TIZANO door leaf model door frames equipped with 3 hinges.

fig. 1

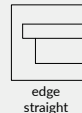
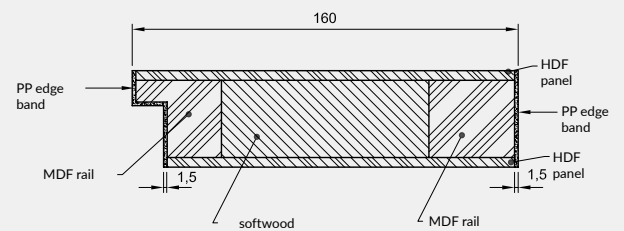

fig. 2



CROSS-SECTION OF VERTICAL STILE





RIVIA 80 - white mat/elm anthracite

Decor DRE-Cell	white mat	white pine	elm siberian	silver	oak sand	bleached oak textured	ash	vintage oak	beech	alder	golden oak	golden oak textured	calvados
	walnut	walnut caramel	dark walnut textured	gray oak textured	elm tabac	elm anthracite	wenge dark						
Decor 3D	grand oak	elm	walnut american	ebony	polish oak 3D								

STANDARD OPTION

- » door leaf frame made of softwood
- » core made of perforated chipboard
- » glass pane white bark 4 mm thick

OPTION WITHOUT ADDITIONAL CHARGE

- » glass pane „chinchila” or „window blind”
- » ventilation sleeves
- » three hinges - applies to rebated door leaf

REBATED DOOR LEAF

- » straight edge, flat uniform glazing bar **fig. 1**
- » 2 silver screw-in pivot hinges
- » single-point mortise lock for simple key, for bathroom lock, for cylinder lock or economic lock

NON-REBATED DOOR LEAF (extra charge)

- » edge without rebate, flat uniform glazing bar, **rys. 2**
- » sockets for 3 hidden concealed W1078 hinges (non-rebated door frames are equipped with hinges)
- » magnetic lock for simple key, for bathroom lock, for cylinder lock or economic lock

SLIDING SYSTEM DOOR LEAF

- » edge without rebate, flat uniform glazing bar **fig. 2**
- » socket for hook lock and/or for handles

OPTIONS AVAILABLE WITH EXTRA CHARGE

- » glass pane MAT DRE, DECORMAT BROWN, DECORMAT GRAPHITE, (applies to door leaf)
RIVIA 20, 30
RIVIA 40, 50
- » non-rebated door leaf
- » door leaf „90” and „100”
- » ventilation undercut
- » plastic ventilation grille
- » aluminum ventilation grille

fig. 1

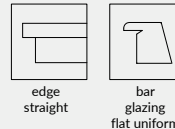
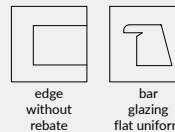

fig. 2



NOTE: Door leaf is coated with decor white mat. There is possibility to choose middle stripe in the selected decor. Edgeband is in the colour of selected decor. RIVIA 50 - BULAJ is coated with silver laminate.

*** In Rivia 70 and 120 model colour of te selected decor has vertical wood grain, except decor gray oak texture. In remaining models decors horizontal wood grain.





GALERIA ALU 20 vintage oak

Decor DRE-Cell 1	white (structure)	ash	beech	alder	golden oak	calvados	walnut														
Decor DRE-Cell 2	white mat	white pine	elm siberian	silver	oak sand	bleached oak textured	vintage oak	walnut caramel	golden oak textured	dark walnut textured	gray oak textured***										
	elm tabac	elm anthracite	wenge dark																		
Decor 3D	grand oak	elm	walnut american	ebony	polish oak 3D																

*** decor available only in horizontal wood grain

STANDARD OPTION

- » door leaf frame made of softwood
- » core made of perforated chipboard
- » aluminum marquetry elements with cross-section 8x2mm
- » glass pane white bark 4 mm thick

OPTION WITHOUT ADDITIONAL CHARGE

- » glass pane „chinchila” or „window blind”
- » ventilation sleeves
- » three hinges - applies to rebated door leaf

REBATED DOOR LEAF

- » straight edge, flat glazing bar **fig. 1**
- » 2 silver screw-in pivot hinges
- » single-point mortise lock for simple key, for bathroom lock, for cylinder lock or economic lock

NON-REBATED DOOR LEAF (EXTRA CHARGE)

- » edge without rebate, flat glazing bar **fig. 2**
- » sockets for 3 hidden concealed W1078 hinges (non-rebated door frames are equipped with hinges)
- » magnetic lock for simple key, for bathroom lock, for cylinder lock or economic lock

SLIDING SYSTEM DOOR LEAF

- » edge without rebate, flat glazing bar **fig. 2**
- » socket for hook lock and/or for handles

OPTIONS AVAILABLE WITH EXTRA CHARGE

- » glass pane MAT DRE, DECORMAT BROWN, DECORMAT GRAPHITE, (applies to door leaf)
GALERIA ALU 11, 13, 23
GALERIA ALU 21
GALERIA ALU 24, 25
GALERIA ALU 12, 22
- » non-rebated door leaf
» door leaf „90” and „100”
- » ventilation undercut
- » plastic ventilation grille
- » aluminum ventilation grille
- » cover-up strip for double leaf non-rebated door
- » double leaf door

fig. 1

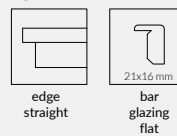
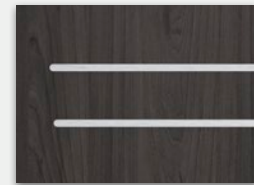
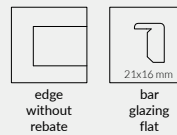
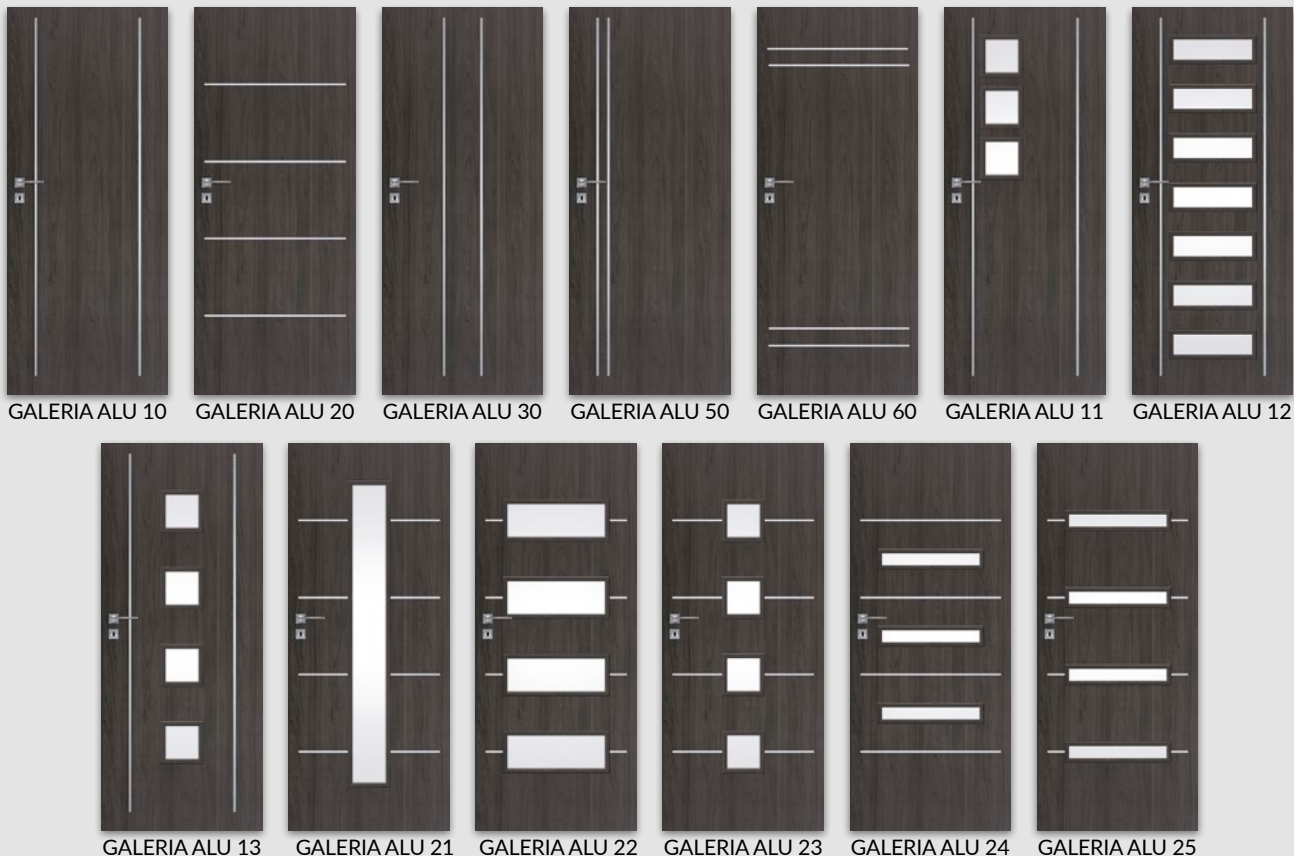

fig. 2



aluminium marquetry elements with cross-section 8x2 mm installed on both sides in one surface of door leaf





ALDEA 20 american walnut

Decor DRE-Cell 1	white (structure)	ash	beech	alder	golden oak	calvados	walnut						
Decor DRE-Cell 2	white mat	white pine	elm siberian	silver	oak sand	bleached oak textured	vintage oak	walnut caramel	golden oak textured	dark walnut textured	gray oak textured***		
	elm tabac	elm anthracite	wenge dark										
Decor 3D	grand oak	elm	walnut american	ebony	polish oak 3D								

*** decor available only in horizontal wood grain

STANDARD OPTION

- » door leaf frame made of softwood
- » core made of „honeycomb“
- » glass pane white bark 4 mm thick

OPTION WITHOUT ADDITIONAL CHARGE

- » glass pane „chinchila“ or „window blind“
- » ventilation sleeves
- » three hinges - applies to rebated door leaf

REBATED DOOR LEAF

- » straight edge, flat glazing bar, 19 mm MDF profiled panels **fig. 1**
- » 2 silver screw-in pivot hinges
- » single-point mortise lock for simple key, for bathroom lock, for cylinder lock or economic lock

NON-REBATED DOOR LEAF (extra charge)

- » edge without rebate, flat glazing bar, 19 mm MDF profiled panels **fig. 2**
- » sockets for 3 hidden concealed W1078 hinges (non-rebated door frames are equipped with hinges)
- » magnetic lock for simple key, for bathroom lock, for cylinder lock or economic lock

SLIDING SYSTEM DOOR LEAF

- » edge without rebate, flat glazing bar, 19 mm MDF profiled panels **fig. 2**
- » socket for hook lock and/or for handles

OPTIONS AVAILABLE WITH EXTRA CHARGE

- » glass pane MAT DRE, DECORMAT BROWN, DECORMAT GRAPHITE, (applies to door leaf)
 - ALDEA 20
 - ALDEA 30
 - ALDEA 40
 - ALDEA 50
 - ALDEA 60
- » core made of perforated chipboard
- » non-rebated door leaf
- » door leaf „90“ and „100“
- » ventilation undercut
- » plastic ventilation grille
- » aluminum ventilation grille
- » cover-up strip for double leaf non-rebated door
- » double leaf door

fig. 1

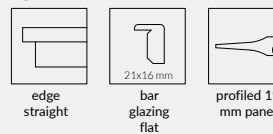
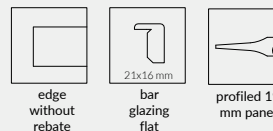

fig. 2





ARTE B 40 vintage oak

Decor DRE-Cell 1	white (structure)	ash	beech	alder	golden oak	calvados	walnut					
Decor DRE-Cell 2	white mat	white pine	elm siberian	silver	oak sand	bleached oak textured	vintage oak	walnut caramel	golden oak textured	dark walnut textured	gray oak textured***	
	elm tabac	elm anthracite	wenge dark									
Decor 3D	grand oak	elm	walnut american	ebony	polish oak 3D							

*** decor available only in horizontal wood grain

STANDARD OPTION

- » door leaf frame made of softwood
- » core made of „honeycomb“
- » glass pane white bark 4 mm thick

OPTION WITHOUT ADDITIONAL CHARGE

- » glass pane „chinchila“ or „window blind“
- » ventilation sleeves
- » three hinges - applies to rebated door leaf

OPTIONS AVAILABLE WITH EXTRA CHARGE

- » glass pane MAT DRE, DECORMAT BROWN, DECORMAT GRAPHITE, (applies to door leaf)
ARTE B 10-30
ARTE B 40, 50
ARTE B 60
- » core made of perforated chipboard
- » non-rebated door leaf
- » door leaf „90“ and „100“
- » ventilation undercut
- » plastic ventilation grille
- » aluminum ventilation grille
- » cover-up strip for double leaf non-rebated door
- » double leaf door

REBATED DOOR LEAF

- » straight edge, flat glazing bar **fig. 1**
- » 2 silver screw-in pivot hinges
- » single-point mortise lock for simple key, for bathroom lock, for cylinder lock or economic lock

NON-REBATED DOOR LEAF (extra charge)

- » edge without rebate, flat glazing bar, **fig. 2**
- » sockets for 3 hidden concealed W1078 hinges (non-rebated door frames are equipped with hinges)
- » magnetic lock for simple key, for bathroom lock, for cylinder lock or economic lock

SLIDING SYSTEM DOOR LEAF

- » edge without rebate, flat glazing bar **fig. 2**
- » socket for hook lock and/or for handles

fig. 1

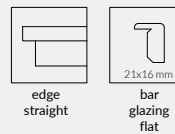
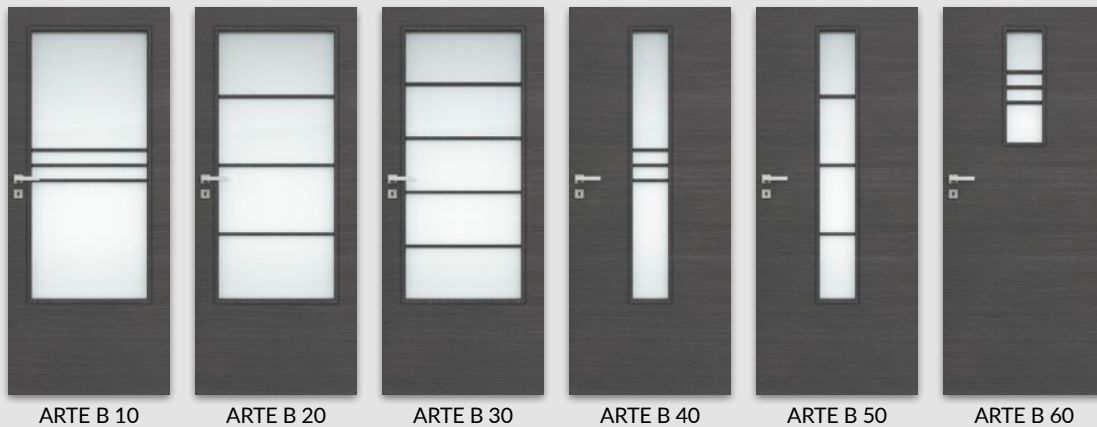
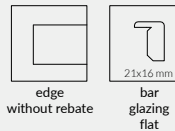

fig. 2





CARLA 10 grand oak

Decor DRE-Cell 1	white (structure)	ash	beech	alder	golden oak	calvados	walnut				
Decor DRE-Cell 2	white mat	white pine	elm siberian	silver	oak sand	bleached oak textured	vintage oak	walnut caramel	golden oak textured	dark walnut textured	gray oak textured***
	elm tabac	elm anthracite	wenge dark								
Decor 3D	grand oak	elm	walnut american	ebony	polish oak 3D						

*** decor available only in horizontal wood grain

STANDARD OPTION

- » door leaf frame made of softwood
- » core made of „honeycomb“
- » glass pane white bark 4 mm thick

OPTION WITHOUT ADDITIONAL CHARGE

- » glass pane „chinchila“ or „window blind“
- » ventilation sleeves
- » three hinges - applies to rebated door leaf

REBATED DOOR LEAF

- » straight edge, flat glazing bar, 19 mm MDF profiled panels **fig. 1**
- » 2 silver screw-in pivot hinges
- » single-point mortise lock for simple key, for bathroom lock, for cylinder lock or economic lock

NON-REBATED DOOR LEAF (extra charge)

- » edge without rebate, flat glazing bar, 19 mm MDF profiled panels **fig. 2**
- » sockets for 3 hidden concealed W1078 hinges (non-rebated door frames are equipped with hinges)
- » magnetic lock for simple key, for bathroom lock, for cylinder lock or economic lock

SLIDING SYSTEM DOOR LEAF

- » edge without rebate, flat glazing bar, 19 mm MDF profiled panels **fig. 2**
- » socket for hook lock and/or for handles

OPTIONS AVAILABLE WITH EXTRA CHARGE

- » glass pane MAT DRE, DECORMAT BROWN, DECORMAT GRAPHITE (applies to door leaf)
CARLA 20
CARLA 30
CARLA 40
- » core made of perforated chipboard
- » non-rebated door leaf
- » door leaf „90“ and „100“
- » ventilation undercut
- » plastic ventilation grille
- » aluminum ventilation grille
- » cover-up strip for double leaf non-rebated door
- » double leaf door

fig. 1

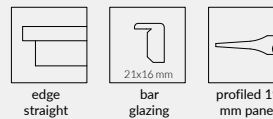
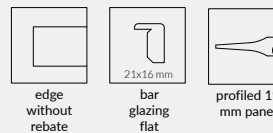

fig. 2



CARLA 10

CARLA 20

CARLA 30

CARLA 40



BLANCO 110 with mirror - white mat

Decor
DRE-Cell



STANDARD OPTION

- » door leaf frame made of softwood
- » core made of „honeycomb“
- » glass pane white bark 4 mm thick
- » 8 mm complex mirror in BLANCO 110

OPTION WITHOUT ADDITIONAL CHARGE

- » glass pane „chinchila“ or „window blind“
- » ventilation sleeves
- » three hinges - applies to rebated door leaf

REBATED DOOR LEAF

- » straight edge, flat uniform glazing bar **fig. 1**
- » 2 silver screw-in pivot hinges
- » single-point mortise lock for simple key, for bathroom lock, for cylinder lock or economic lock

NON-REBATED DOOR LEAF (extra charge)

- » edge without rebate, flat uniform glazing bar **fig. 2**
- » sockets for 3 hidden concealed W1078 hinges (non-rebated door frames are equipped with hinges)
- » magnetic lock for simple key, for bathroom lock, for cylinder lock or economic lock

SLIDING SYSTEM DOOR LEAF

- » edge without rebate, flat uniform glazing bar **fig. 2**
- » socket for hook lock and/or for handles

OPTIONS AVAILABLE WITH EXTRA CHARGE

- » glass pane MAT DRE, DECORMAT BROWN, DECORMAT GRAPHITE (applies to door leaf)
BLANCO 10, 80
BLANCO 20-40
BLANCO 50
BLANCO 60, 100
BLANCO 70
BLANCO 90
- » non-rebated door leaf
- » core made of perforated chipboard
- » door leaf „90“ and „100“
- » ventilation undercut
- » plastic ventilation grille
- » aluminum ventilation grille
- » cover-up strip for double leaf non-rebated door
- » double leaf door

fig. 1

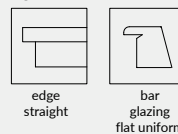
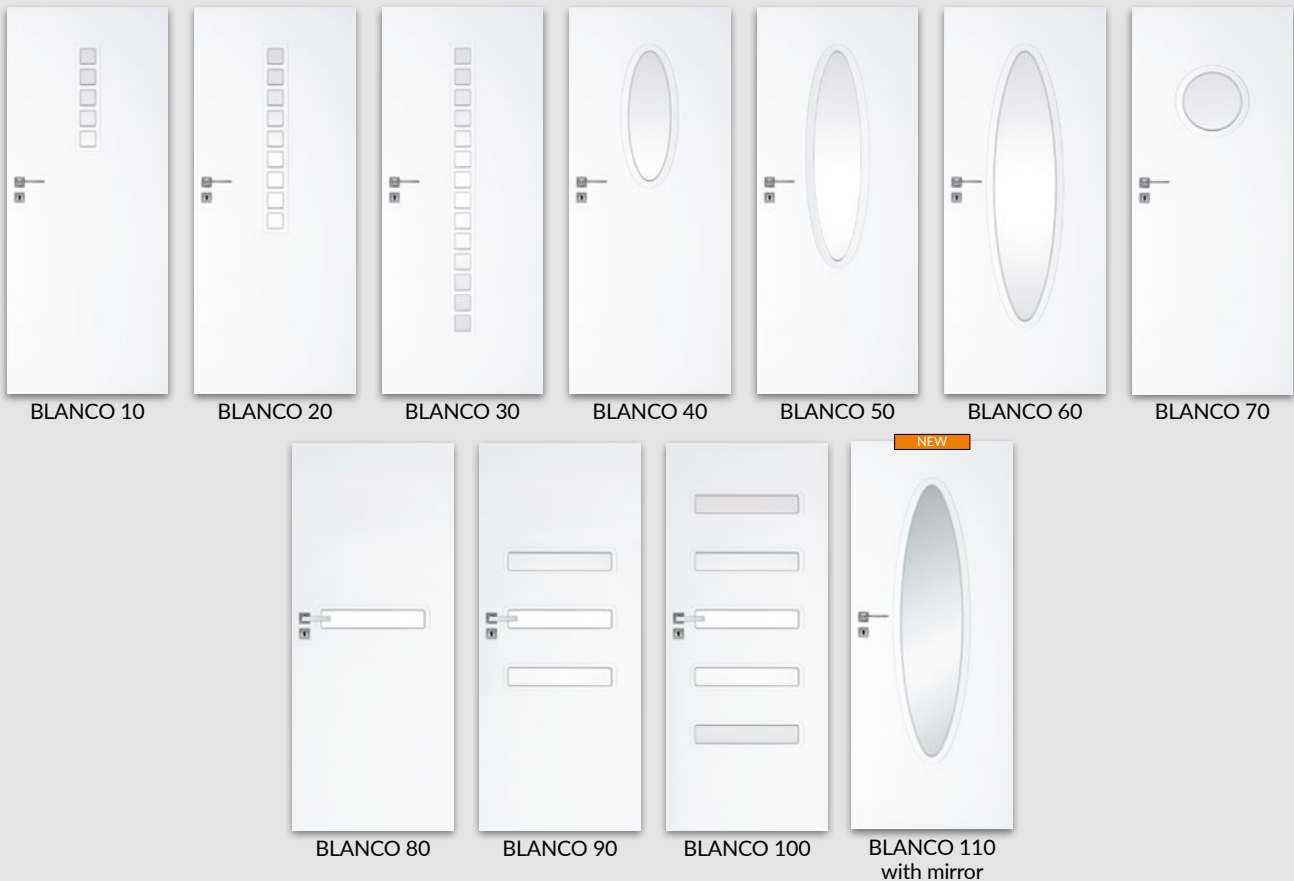
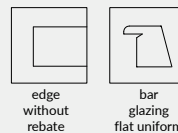

fig. 2





FINEA 40 vintage oak

Decor DRE-Cell 1	white (structure)	ash	beech	alder	golden oak	calvados	walnut						
Decor DRE-Cell 2	white mat	white pine	elm siberian	silver	oak sand	bleached oak textured	vintage oak	walnut caramel	golden oak textured	dark walnut textured	gray oak textured***		
	elm tabac	elm anthracite	wenge dark										
Decor 3D	grand oak	elm	walnut american	ebony	polish oak 3D								

*** decor available only in horizontal wood grain

STANDARD OPTION

- » door leaf frame made of softwood
- » core made of perforated chipboard
- » glass pane white bark 4 mm thick

OPTION WITHOUT ADDITIONAL CHARGE

- » glass pane „chinchila” or „window blind”
- » ventilation sleeves
- » three hinges - applies to rebated door leaf

OPTIONS AVAILABLE WITH EXTRA CHARGE

- » glass pane MAT DRE, DECORMAT BROWN, DECORMAT GRAPHITE (applies to door leaf) FINEA 20, FINEA B 20 FINEA 30, 50, 60, FINEA B 30, 50, 60
- » non-rebated door leaf
- » door leaf „90” and „100”
- » ventilation undercut
- » plastic ventilation grille
- » aluminum ventilation grille

REBATED DOOR LEAF

- » straight edge, flat glazing bar **fig. 1**
- » 2 silver screw-in pivot hinges
- » single-point mortise lock for simple key, for bathroom lock, for cylinder lock or economic lock

NON-REBATED DOOR LEAF (EXTRA CHARGE)

- » edge without rebate, flat glazing bar **fig. 2**
- » sockets for 3 hidden concealed W1078 hinges (non-rebated door frames are equipped with hinges)
- » magnetic lock for simple key, for bathroom lock, for cylinder lock or economic lock

SLIDING SYSTEM DOOR LEAF

- » edge without rebate, flat glazing bar **fig. 2**
- » socket for hook lock and/or for handles

fig. 1

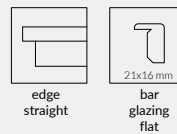
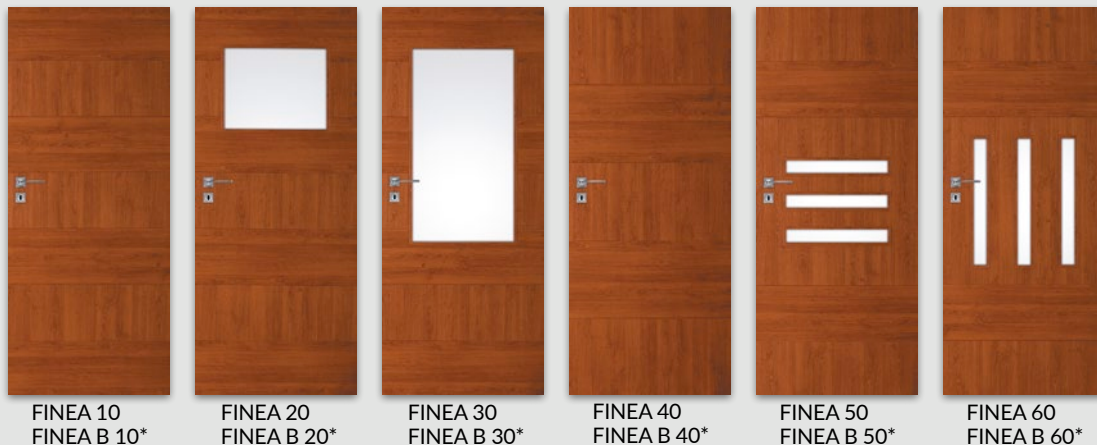
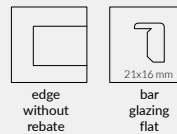
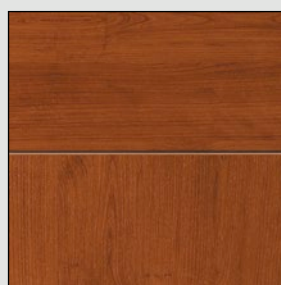

fig. 2



* FINEA B panels available only with horizontal wood grain



panels wood grain in FINEA



panels horizontal wood grain FINEA B



DECO 10 - grand oak

Decor DRE-Cell 1	white (structure)	ash	beech	alder	golden oak	calvados	walnut											
Decor DRE-Cell 2	white mat*	white pine	elm siberian	silver	oak sand	bleached oak textured	vintage oak	walnut caramel	golden oak textured	dark walnut textured	gray oak textured***							
	elm tabac	elm anthracite	wenge dark															
Decor 3D	grand oak	elm	walnut american	ebony	polish oak 3D													
NEW Laminate CPL	white	white noble VVF7206	light gray	gray dark	concrete 1 F6462	gray oak	welsh oak	acacia	celini walnut	walnut	honey oak	chestnut	roasted walnut					

*** decor available only in horizontal wood grain

* decor is not available in door leaf model with "karnies" edge

*** decor available only in horizontal wood grain

STANDARD OPTION

- » door leaf frame made of softwood
- » edge with radius R 2,5 mm used in 0,15-0,20 mm CPL laminates
- » core made of „honeycomb“
- » glass pane white bark 4 mm thick
- » flat 4mm HDF panel in DECO 40

OPTION WITHOUT ADDITIONAL CHARGE

- » glass pane „chinchila“ or „window blind“
- » ventilation sleeves
- » three hinges - applies to rebated door leaf

REBATED DOOR LEAF

- » optional: straight edge, flat glazing bar fig. 1 or "karnies" edge, rounded glazing bar fig. 2
- » 2 silver screw-in pivot hinges
- » single-point mortise lock for simple key, for bathroom lock, for cylinder lock or economic lock
- » rounded glazing bar, straight edge coated with 1,5 mm edgeband or edge with radius R 2,5 mm finished with method of directforming (in CPL laminate) fig. 5

NON-REBATED DOOR LEAF (extra charge)

- » edge without rebate, flat glazing bar fig. 3
- » sockets for 3 hidden concealed W1078 hinges (non-rebated door frames are equipped with hinges)
- » magnetic lock for simple key, for bathroom lock, for cylinder lock or economic lock

- » edge without rebate, rounded glazing bar (in CPL laminate) fig. 6

SLIDING SYSTEM DOOR LEAF

- » edge without rebate and optional: flat glazing bar fig.3 or rounded glazing bar fig. 4
- » socket for hook lock and/or for handles
- » doesn't concern CPL laminates

OPTIONS AVAILABLE WITH EXTRA CHARGE

- » straight edge and edge without rebate finished with 1,5 mm edgeband in CPL laminates
- » glass pane MAT DRE, DECORMAT BROWN, DECORMAT GRAPHITE (applies to door leaf) DECO 10-30
- » core made of perforated chipboard
- » non-rebated door leaf
- » door leaf „90“ and „100“
- » ventilation undercut
- » plastic ventilation grille
- » aluminum ventilation grille
- » cover-up strip for double leaf non-rebated door
- » double leaf door

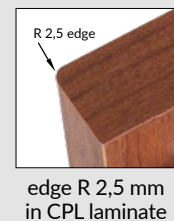
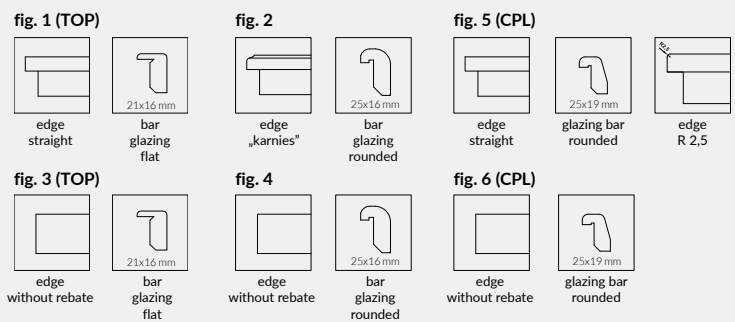



MODERN 10 - white pine

Decor DRE-Cell 1	white (structure)	ash	beech	alder	golden oak	calvados	walnut				
Decor DRE-Cell 2	white mat*	white pine	elm siberian	silver	oak sand	bleached oak textured	vintage oak	walnut caramel	golden oak textured	dark walnut textured	gray oak textured***
	elm tabac	elm anthracite	wenge dark								
Decor 3D	grand oak	elm	walnut american	ebony	polish oak 3D						

*** decor available only in horizontal wood grain

* decor is not available in door leaf model with "karnies" edge

*** decor available only in horizontal wood grain

STANDARD OPTION

- » door leaf frame made of softwood
- » core made of „honeycomb“
- » glass pane white bark 4 mm thick

OPTION WITHOUT ADDITIONAL CHARGE

- » glass pane „chinchila“ or „window blind“
- » ventilation sleeves
- » three hinges - applies to rebated door leaf

REBATED DOOR LEAF

- » optional: straight edge, flat glazing bar, flat 4 mm HDF panels **fig. 1** or „karnies“ edge, rounded glazing bar, profiled 19 mm MDF panels **fig. 2**
- » 2 silver screw-in pivot hinges
- » single-point mortise lock for simple key, for bathroom lock, for cylinder lock or economic lock

NON-REBATED DOOR LEAF (extra charge)

- » edge without rebate, flat glazing bar, flat 4 mm HDF panels **fig. 3**
- » sockets for 3 hidden concealed W1078 hinges (non-rebated door frames are equipped with hinges)
- » magnetic lock for simple key, for bathroom lock, for cylinder lock or economic lock

SLIDING SYSTEM DOOR LEAF

- » edge without rebate and optional: flat glazing bar, flat 4 mm HDF panels **fig. 3** or rounded glazing bar, profiled 19 mm MDF panels **fig. 4**
- » socket for hook lock and/or for handles

OPTIONS AVAILABLE WITH EXTRA CHARGE

- » glass pane MAT DRE, DECORMAT BROWN, DECORMAT GRAPHITE, (applies to door leaf) MODERN 20 MODERN 30 MODERN 40 MODERN 50
- » core made of perforated chipboard
- » non-rebated door leaf
- » door leaf „90“ and „100“
- » ventilation undercut
- » plastic ventilation grille
- » aluminum ventilation grille
- » cover-up strip for double leaf non-rebated door
- » double leaf door

fig. 1 (TOP)

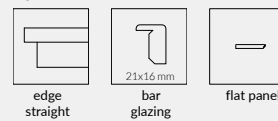

fig. 2

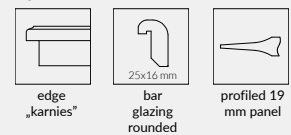

fig. 3 (TOP)

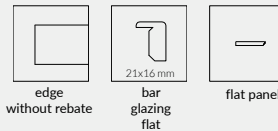
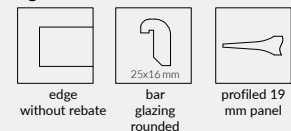

fig. 4



MODERN 10

MODERN 20

MODERN 30

MODERN 40

MODERN 50



KANON 30 - ebony

Decor DRE-Cell 1	white (structure)	ash	beech	alder	golden oak	calvados	walnut						
Decor DRE-Cell 2	white mat*	white pine	elm siberian	silver	oak sand	bleached oak textured	vintage oak	walnut caramel	golden oak textured	dark walnut textured	gray oak textured***		
	elm tabac	elm anthracite	wenge dark										
Decor 3D	grand oak	elm	walnut american	ebony	polish oak 3D								

*** decor available only in horizontal wood grain

* decor is not available in door leaf model with "karnies" edge

*** decor available only in horizontal wood grain

STANDARD OPTION

- » door leaf frame made of softwood
- » core made of „honeycomb“
- » glass pane white bark 4 mm thick

OPTION WITHOUT ADDITIONAL CHARGE

- » glass pane „chinchila“ or „window blind“
- » ventilation sleeves
- » three hinges - applies to rebated door leaf

REBATED DOOR LEAF

- » optional: straight edge, flat glazing bar, flat 4 mm HDF panels **fig. 1** or „karnies“ edge, rounded glazing bar, profiled 19 mm MDF panels **fig. 2**
- » 2 silver screw-in pivot hinges
- » single-point mortise lock for simple key, for bathroom lock, for cylinder lock or economic lock

NON-REBATED DOOR LEAF (EXTRA CHARGE)

- » edge without rebate, flat glazing bar, flat 4 mm HDF panels **fig. 3**
- » sockets for 3 hidden concealed W1078 hinges (non-rebated door frames are equipped with hinges)
- » magnetic lock for simple key, for bathroom lock, for cylinder lock or economic lock

SLIDING SYSTEM DOOR LEAF

- » edge without rebate and optional: flat glazing bar, flat 4 mm HDF panels **fig. 3** or rounded glazing bar, profiled 19 mm MDF panels **fig. 4**
- » socket for hook lock and/or for handles

OPTIONS AVAILABLE WITH EXTRA CHARGE

- » glass pane MAT DRE, DECORMAT BROWN, DECORMAT GRAPHITE, (applies to door leaf) KANON 20 KANON 30 KANON 40
- » core made of perforated chipboard
- » non-rebated door leaf
- » door leaf „90“ and „100“
- » ventilation undercut
- » plastic ventilation grille
- » aluminum ventilation grille
- » cover-up strip for double leaf non-rebated door
- » double leaf door

fig. 1 (TOP)

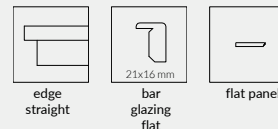

fig. 2



fig. 3 (TOP)

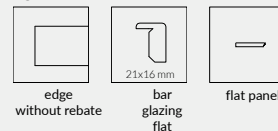
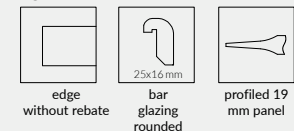

fig. 4



KANON 10

KANON 20

KANON 30

KANON 40



IDEA 30 - elm anthracite

Decor DRE-Cell 1	white (structure)	ash	beech	alder	golden oak	calvados	walnut					
Decor DRE-Cell 2	white mat*	white pine	elm siberian	silver	oak sand	bleached oak textured	vintage oak	walnut caramel	golden oak textured	dark walnut textured	gray oak textured***	
	elm tabac	elm anthracite	wenge dark									
Decor 3D	grand oak	elm	walnut american	ebony	polish oak 3D							

*** decor available only in horizontal wood grain

* decor is not available in door leaf model with "karnies" edge

*** decor available only in horizontal wood grain

STANDARD OPTION

- » door leaf frame made of softwood
- » core made of „honeycomb”
- » glass pane white bark 4 mm thick

OPTION WITHOUT ADDITIONAL CHARGE

- » glass pane „chinchila” or „window blind”
- » ventilation sleeves
- » three hinges - applies to rebated door leaf

REBATED DOOR LEAF

- » optional: straight edge, flat glazing bar, flat 4 mm HDF panels **fig. 1** or „karnies” edge, rounded glazing bar, profiled 19 mm MDF panels **fig. 2**
- » 2 silver screw-in pivot hinges
- » single-point mortise lock for simple key, for bathroom lock, for cylinder lock or economic lock

NON-REBATED DOOR LEAF (EXTRA CHARGE)

- » edge without rebate, flat glazing bar, flat 4 mm HDF panels **fig. 3**
- » sockets for 3 hidden concealed W1078 hinges (non-rebated door frames are equipped with hinges)
- » magnetic lock for simple key, for bathroom lock, for cylinder lock or economic lock

SLIDING SYSTEM DOOR LEAF

- » edge without rebate and optional: flat glazing bar, flat 4 mm HDF panels **fig. 3** or rounded glazing bar, profiled 19 mm MDF panels **fig. 4**
- » socket for hook lock and/or for handles

OPTIONS AVAILABLE WITH EXTRA CHARGE

- » glass pane MAT DRE, DECORMAT BROWN, DECORMAT GRAPHITE (applies to door leaf) IDEA 20, 40, 50, 70, 80 IDEA 30, 90, 100, 110, 120 IDEA 60
- » core made of perforated chipboard
- » non-rebated door leaf
- » door leaf „90” and „100”
- » ventilation undercut
- » plastic ventilation grille
- » aluminum ventilation grille
- » cover-up strip for double leaf non-rebated door
- » non-rebated
- » double leaf door

fig. 1 (TOP)

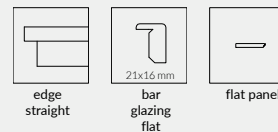

fig. 2

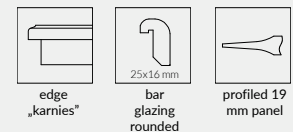

fig. 3 (TOP)

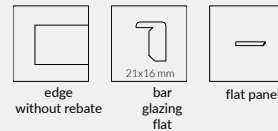
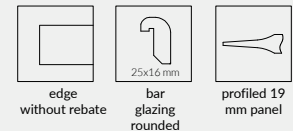

fig. 4





PLUS 30 - elm

Decor DRE-Cell 1	white (structure)	ash	beech	alder	golden oak	calvados	walnut						
Decor DRE-Cell 2	white mat*	white pine	elm siberian	silver	oak sand	bleached oak textured	vintage oak	walnut caramel	golden oak textured	dark walnut textured	gray oak textured***		
	elm tabac	elm anthracite	wenge dark										
Decor 3D	grand oak	elm	walnut american	ebony	polish oak 3D								

*** decor available only in horizontal wood grain

* decor is not available in door leaf model with "karnies" edge

*** decor available only in horizontal wood grain

STANDARD OPTION

- » door leaf frame made of softwood
- » core made of „honeycomb“
- » glass pane white bark 4 mm thick

OPTION WITHOUT ADDITIONAL CHARGE

- » glass pane „chinchila“ or „window blind“
- » ventilation sleeves
- » three hinges - applies to rebated door leaf

REBATED DOOR LEAF

- » optional: straight edge, flat glazing bar, flat 4 mm HDF panels fig. 1 or "karnies" edge, rounded glazing bar, flat 4 mm HDF panels fig. 2
- » 2 silver screw-in pivot hinges
- » single-point mortise lock for simple key, for bathroom lock, for cylinder lock or economic lock

NON-REBATED DOOR LEAF (extra charge)

- » edge without rebate, flat glazing bar, flat 4 mm HDF panels fig. 3
- » sockets for 3 hidden concealed W1078 hinges (non-rebated door frames are equipped with hinges)
- » magnetic lock for simple key, for bathroom lock, for cylinder lock or economic lock

SLIDING SYSTEM DOOR LEAF

- » edge without rebate, flat 4 mm HDF panels and optional: flat glazing bar, fig. 3 or rounded glazing bar fig. 4
- » socket for hook lock and/or for handles

OPTIONS AVAILABLE WITH EXTRA CHARGE

- » glass pane MAT DRE, DECORMAT BROWN, DECORMAT GRAPHITE (applies to door leaf) PLUS 20 PLUS 40, 50, 60, 70, 80 PLUS 30
- » core made of perforated chipboard
- » non-rebated door leaf
- » door leaf „90“ and „100“
- » ventilation undercut
- » plastic ventilation grille
- » aluminum ventilation grille
- » cover-up strip for double leaf non-rebated door
- » double leaf door

fig. 1 (TOP)

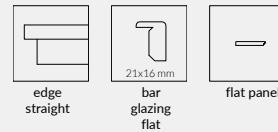

fig. 2

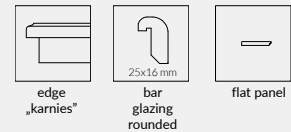

fig. 3 (TOP)

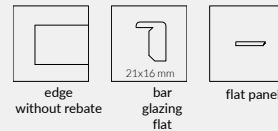
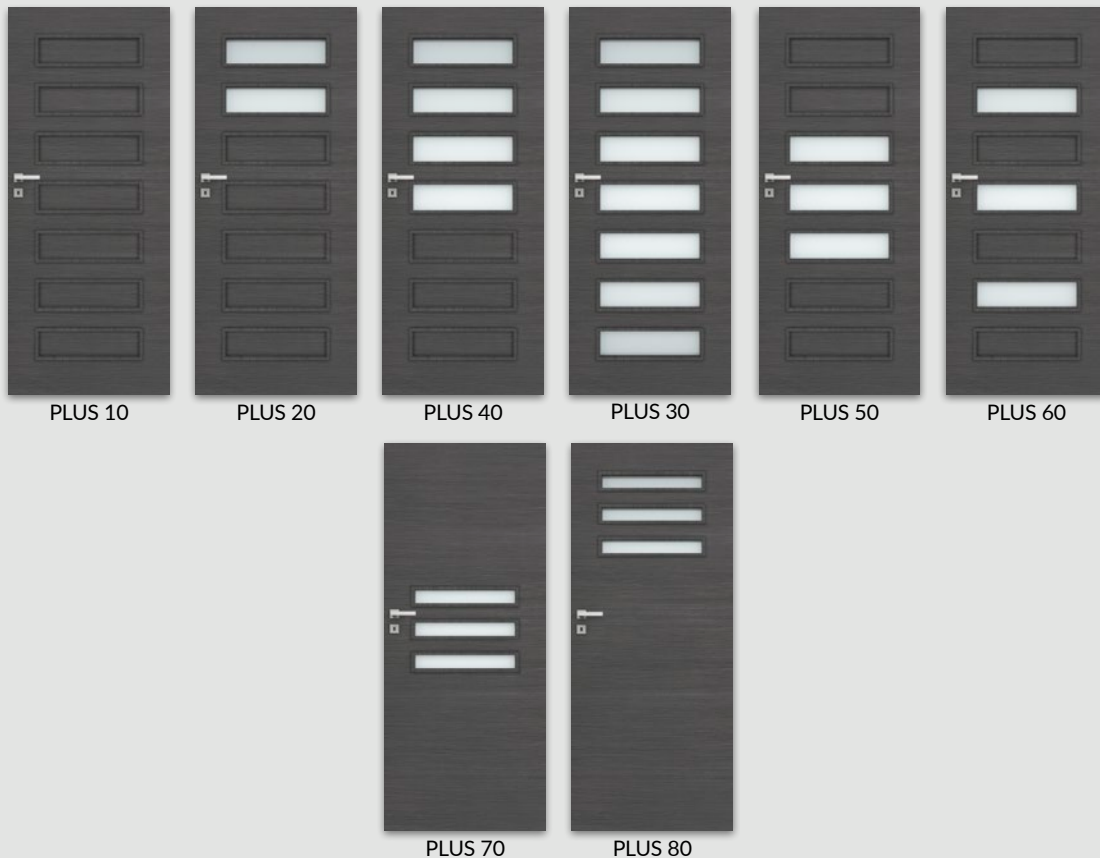
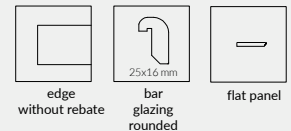

fig. 4





STANDARD 40 and STANDARD 10 - walnut

Decor DRE-Cell 1	white (structure)	ash	beech	alder	golden oak	calvados	walnut						
Decor DRE-Cell 2	white mat*	white pine	elm siberian	silver	oak sand	bleached oak textured	vintage oak	walnut caramel	golden oak textured	dark walnut textured	gray oak textured***		
	elm tabac	elm anthracite	wenge dark										
Decor 3D	grand oak	elm	walnut american	ebony	polish oak 3D								

*** decor available only in horizontal wood grain

* decor is not available in door leaf model with "karnies" edge

*** decor available only in horizontal wood grain

STANDARD OPTION

- » door leaf frame made of softwood
- » core made of „honeycomb“
- » glass pane white bark 4 mm thick

OPTION WITHOUT ADDITIONAL CHARGE

- » glass pane „chinchila“ or „window blind“
- » ventilation sleeves
- » three hinges - applies to rebated door leaf

REBATED DOOR LEAF

- » optional: straight edge, flat glazing bar fig.1 or "karnies" edge, rounded glazing bar, fig. 2
- » 2 silver screw-in pivot hinges
- » single-point mortise lock for simple key, for bathroom lock, for cylinder lock or economic lock

NON-REBATED DOOR LEAF (extra charge)

- » edge without rebate, flat glazing bar fig.3
- » sockets for 3 hidden concealed W1078 hinges (non-rebated door frames are equipped with hinges)
- » magnetic lock for simple key, for bathroom lock, for cylinder lock or economic lock

SLIDING SYSTEM DOOR LEAF

- » edge without rebate and optional: flat glazing bar fig. 3 or rounded glazing bar fig.4
- » socket for hook lock and/or for handles

OPTIONS AVAILABLE WITH EXTRA CHARGE

- » glass pane MAT DRE, DECORMAT BROWN, DECORMAT GRAPHITE (applies to door leaf) STANDARD 20, 20s, 40, 40s, BULAJ MDF
- » STANDARD 50, 50s
- » STANDARD 30, 30s
- » STANDARD 60
- » core made of perforated chipboard
- » non-rebated door leaf
- » door leaf „90“ and „100“
- » rebated door leaf "110" (only STANDARD 10)
- » additional upper single point mortise lock (available only in STANDARD 10 door leaf model with core made of perforated chipboard and fixed door frame)
- » ventilation undercut
- » plastic ventilation grille
- » aluminum ventilation grille
- » cover-up strip for double leaf non-rebated door
- » double leaf door door leaf price x 2
- » there is possibility to purchase steel bulaj separately

fig. 1

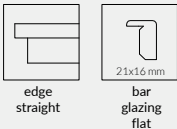

fig. 2

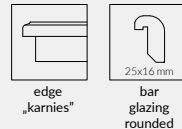

fig. 3

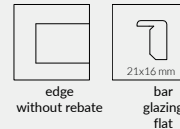
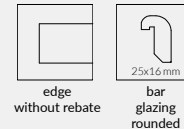
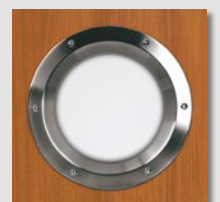

fig. 4



additional upper single point mortise lock (available only in STANDARD 10 door leaf model with core made of perforated chipboard and fixed door frame)



steel BULAJ (available only MAT or transparent glass pane)



RIM 20 - bleached oak textured

Decor DRE-Cell	white (structure)	white mat	white pine	elm siberian	silver	oak sand	bleached oak textured	vintage oak	ash	beech	alder	golden oak	golden oak textured
	calvados	walnut	walnut caramel	dark walnut textured	gray oak textured***	elm tabac	elm anthracite	wenge dark					
Decor 3D	grand oak	elm	walnut american	ebony	polish oak 3D								

*** decor available only in horizontal wood grain

STANDARD OPTION

- » reinforced door leaf frame
- » core made of perforated chipboard
- » 8 mm tempered glass - decormat

OPTION WITHOUT ADDITIONAL CHARGE

- » glass pane DECORMAT BROWN, DECORMAT GRAPHITE or transparent glass pane
- » ventilation sleeves

REBATED DOOR LEAF

- » straight edge **fig. 1**
- » 3 silver screw-in pivot hinges
- » single-point mortise lock for simple key, for bathroom lock, for cylinder lock or economic lock

NON-REBATED DOOR LEAF RIM 10 AND RIM 20 (EXTRA CHARGE)

- » edge without rebate, **fig. 2**
- » sockets for 3 hidden concealed W1078 hinges (non-rebated door frames are equipped with hinges)
- » magnetic lock for simple key, for bathroom lock, for cylinder lock or economic lock

NOTE: In RIM collection, non-rebated version of door leaf, is only available with models RIM 10 and RIM 20.

* only rebated door leaf

NOTE: It is required to use together with RIM door leaf model door frames equipped with 3 hinges.

NOTE: Glass panes in RIM collection have obverse and reverse sides. When choosing a reverse version, glass pane is rotated by 180° around the vertical axis. Glass pane in RIM models doesn't adhere to gasket.

OPTIONS AVAILABLE WITH EXTRA CHARGE

- » door leaf "90" and "100" RIM 10
RIM 20
RIM 30
- » non-rebated door leaf
- » plastic ventilation grille
- » aluminum ventilation grille
- » ventilation undercut

fig. 1



edge
straight

fig. 2



edge
without rebate



RIM 10

RIM 20

RIM 30*



ARTE 50 - siberian elm

Decor DRE-Cell 1	white (structure)	ash	beech	alder	golden oak	calvados	walnut						
Decor DRE-Cell 2	white mat*	white pine	elm siberian	silver	oak sand	bleached oak textured	vintage oak	walnut caramel	golden oak textured	dark walnut textured	gray oak textured***		
	elm tabac	elm anthracite	wenge dark										
Decor 3D	grand oak	elm	walnut american	ebony	polish oak 3D								

*** decor available only in horizontal wood grain

* decor is not available in door leaf model with "karnies" edge

*** decor available only in horizontal wood grain

STANDARD OPTION

- » door leaf frame made of softwood
- » core made of „honeycomb”
- » glass pane white bark 4 mm thick

OPTION WITHOUT ADDITIONAL CHARGE

- » glass pane „chinchila” or „window blind”
- » ventilation sleeves
- » three hinges - applies to rebated door leaf

OPTIONS AVAILABLE WITH EXTRA CHARGE

- » glass pane MAT DRE, DECORMAT BROWN, DECORMAT GRAPHITE (applies to door leaf)
ARTE 10-30, 90
ARTE 40, 50
ARTE 80
- » core made of perforated chipboard
- » door leaf „90” and „100”
- » non-rebated door leaf
- » ventilation undercut
- » plastic ventilation grille
- » aluminum ventilation grille
- » cover-up strip for double leaf non-rebated door
- » double leaf door

REBATED DOOR LEAF

- » "karnies" edge, rounded glazing bar **fig. 1**
- » 2 silver screw-in pivot hinges
- » single-point mortise lock for simple key, for bathroom lock, for cylinder lock or economic lock

NON-REBATED DOOR LEAF (EXTRA CHARGE)

- » edge without rebate, flat glazing bar **fig. 2**
- » sockets for 3 hidden concealed W1078 hinges (non-rebated door frames are equipped with hinges)
- » magnetic lock for simple key, for bathroom lock, for cylinder lock or economic lock

SLIDING SYSTEM DOOR LEAF

- » edge without rebate, rounded glazing bar or flat glazing bar **fig. 3**
- » socket for hook lock and/or for handles

fig. 1

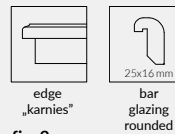

fig. 2

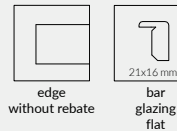
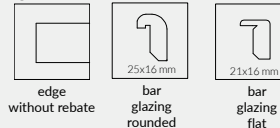

fig. 3



STANDARD OPTION

- » door leaf frame made of softwood
- » core made of „honeycomb“
- » glass pane white bark 4 mm thick

OPTION WITHOUT ADDITIONAL CHARGE

- » glass pane „chinchila“ or „window blind“
- » ventilation sleeves
- » three hinges - applies to rebated door leaf

REBATED DOOR LEAF

- » "karnies" edge, rounded glazing bar, profiled 19mm MDF panel **fig. 1**
- » 2 silver screw-in pivot hinges
- » single-point mortise lock for simple key, for bathroom lock, for cylinder lock or economic lock

NON-REBATED DOOR LEAF (EXTRA CHARGE)

- » edge without rebate, flat glazing bar, 19 mm MDF profiled panels **fig. 2**
- » sockets for 3 hidden concealed W1078 hinges (non-rebated door frames are equipped with hinges)
- » magnetic lock for simple key, for bathroom lock, for cylinder lock or economic lock

SLIDING SYSTEM DOOR LEAF

- » edge without rebate, rounded glazing bar or flat glazing bar, profiled 19 mm MDF panel **fig. 3**
- » socket for hook lock and/or for handles

OPTIONS AVAILABLE WITH EXTRA CHARGE

- » glass pane MAT DRE, DECORMAT BROWN, DECORMAT GRAPHITE (applies to door leaf) FANO 20, 20s FANO 30, 30s
- » core made of perforated chipboard
- » door leaf „90“ and „100“
- » non-rebated door leaf
- » ventilation undercut
- » plastic ventilation grille
- » aluminum ventilation grille
- » cover-up strip for double leaf non-rebated door
- » double leaf door

fig. 1

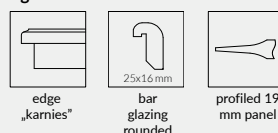

fig. 2

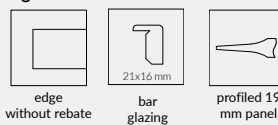

fig. 3



FANO 10

FANO 20

FANO 20s

FANO 30

FANO 30s

Decor DRE-Cell 1	white (structure)	ash	beech	alder	golden oak	calvados	walnut						
	white mat*	white pine	elm siberian	silver	oak sand	bleached oak textured	vintage oak	walnut caramel	golden oak textured	dark walnut textured	gray oak textured***	elm tabac	elm anthracite
Decor 3D	grand oak	elm	walnut american	ebony	polish oak 3D								

* decor is not available in door leaf model with "karnies" edge
*** decor available only in horizontal wood grain

STANDARD OPTION

- » door leaf frame made of softwood
- » core made of „honeycomb”
- » glass pane white bark 4 mm thick

OPTION WITHOUT ADDITIONAL CHARGE

- » glass pane „chinchila” or „window blind”
- » ventilation sleeves
- » three hinges - applies to rebated door leaf

REBATED DOOR LEAF

- » "karnies" edge, rounded glazing bar **fig. 1**
- » 2 silver screw-in pivot hinges
- » single-point mortise lock for simple key, for bathroom lock, for cylinder lock or economic lock

SLIDING SYSTEM DOOR LEAF

- » edge without rebate, rounded glazing bar **fig. 2**
- » socket for hook lock and/or for handles

OPTIONS AVAILABLE WITH EXTRA CHARGE

- » glass pane MAT DRE, DECORMAT BROWN, DECORMAT GRAPHITE (applies to door leaf) LINEA 20, 20s LINEA 30, 30s
- » core made of perforated chipboard
- » additional upper single point mortise lock (available only in LINEA 10 door leaf model with core made of perforated chipboard and fixed door frame)
- » door leaf „90” and „100”
- » ventilation undercut
- » plastic ventilation grille
- » aluminum ventilation grille
- » double leaf door

fig. 1

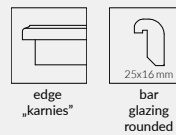
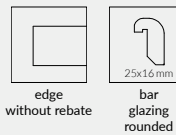

fig. 2



optional:
additional upper single point mortise lock (available only in LINEA 10 door leaf model with core made of perforated chipboard and fixed door frame)



Decor
DRE-Cell

STANDARD OPTION

- » door leaf frame made of softwood
- » core made of „honeycomb“
- » glass pane white bark 4 mm thick

OPTION WITHOUT ADDITIONAL CHARGE

- » glass pane „chinchila“ or „window blind“
- » ventilation sleeves
- » three hinges - applies to rebated door leaf

OPTIONS AVAILABLE WITH EXTRA CHARGE

- » glass pane MAT DRE, DECORMAT BROWN, DECORMAT GRAPHITE (applies to door leaf)
CLASSIC 20, 20s
CLASSIC 30, 30s
- » core made of perforated chipboard
- » door leaf „90“ and „100“
- » ventilation undercut
- » plastic ventilation grille
- » aluminum ventilation grille
- » double leaf door

REBATED DOOR LEAF

- » "karnies" edge, plastic glazing bar **fig. 1**
- » 2 silver screw-in pivot hinges
- » single-point mortise lock for simple key, for bathroom lock, for cylinder lock or economic lock

SLIDING SYSTEM DOOR LEAF

- » edge without rebate, plastic glazing bar **fig. 2**
- » socket for hook lock and/or for handles

fig. 1

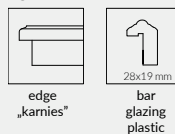
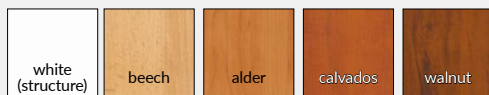

fig. 2



Decor
DRE-Cell



STANDARD OPTION

- » door leaf frame made of MDF
- » core made of „honeycomb”
- » lacquered HDF board
- » glass pane MAT DRE 4 mm thick

OPTION WITHOUT ADDITIONAL CHARGE

- » ventilation sleeves
- » three hinges - applies to rebated door leaf

REBATED DOOR LEAF

- » optional: "karnies" edge **fig. 1** or straight **fig. 2**
- » rounded glazing bar, flat 4 mm HDF board
- » 2 silver screw-in pivot hinges
- » single-point mortise lock for simple key, for bathroom lock, for cylinder lock or economic lock

NOTE: Due to different manufacturing technology:

- » ASCADA door leaf - lacquered HDF board
- » door frames, architraves, Finish quarter rounds - which are coated with Finish decor
- » door leaf edges - edge banding
- » glazing bars, flat 4 mm HDF boards coated with Finish decor.

There are colour differences between those elements.

OPTIONS AVAILABLE WITH EXTRA CHARGE

- » door leaf „90” and „100”
- » plastic ventilation grille
- » ventilation undercut

fig. 1

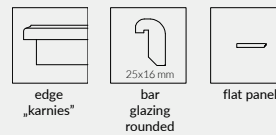
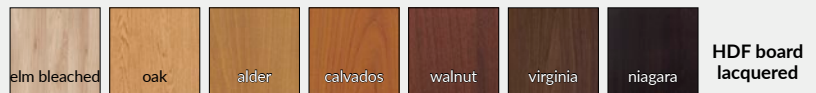
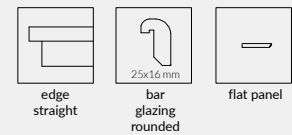

fig. 2



STANDARD OPTION

- » door leaf frame made of MDF
- » core made of „honeycomb”
- » lacquered HDF board
- » glass pane white bark 4 mm thick

OPTION WITHOUT ADDITIONAL CHARGE

- » glass pane "chinchila"
- » ventilation sleeves
- » three hinges applies to rebated door leaf

REBATED DOOR LEAF

- » optional: "karnies" edge **fig. 1** or straight **fig. 2**
- » rounded glazing bar (LACK 20, 30, 40, 40s, 50, 50s) or plastic glazing bar (LACK 20s, 30s)
- » 2 silver screw-in pivot hinges
- » single-point mortise lock for simple key, for bathroom lock, for cylinder lock or economic lock

fig. 1

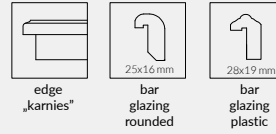
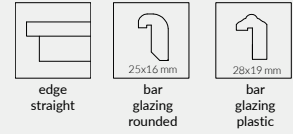

fig. 2



- NOTE: Due to different manufacturing technology:
- » door leaf LACK - lacquered HDF board
 - » door frames, architraves, Finish quarter rounds - which are coated with Finish decor
 - » door leaf edges - edge banding
- There are colour differences between those elements.



HDF board
lacquered

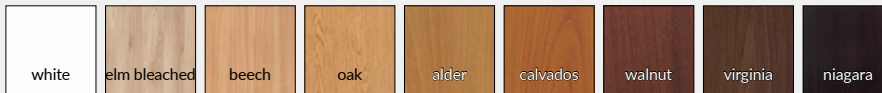

OPTIONS AVAILABLE WITH EXTRA CHARGE

- » glass pane MAT DRE (applies to door leaf) LACK 20, 20s, 40, 40s
LACK 30, 30s
LACK 50, 50s
- » core made of: perforated chipboard LACK 10
- » door leaf „90” and „100”
- » additional upper single point mortise lock (available only in LACK 10 door leaf model with core made of perforated chipboard and fixed door frame)
- » plastic ventilation grille
- » ventilation undercut

optional:



additional upper single point mortise lock
LACK 10 door leaf model with core made
of perforated chipboard and fixed door
frame.



LACK 40

LACK 40s

LACK 50

LACK 50s

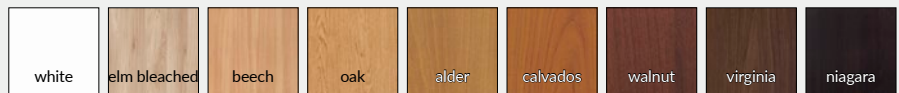

HDF board
lacquered



DUERO natura ALU 60 oak

veneer
natural

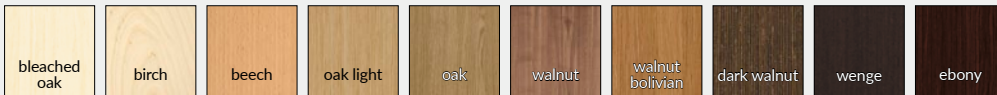

STANDARD OPTION

- » door leaf frame made of softwood
- » core made of perforated chipboard
- » natural veneer secured with UV varnish
- » aluminum marquetry elements with cross - section 8X2 mm

OPTION WITHOUT ADDITIONAL CHARGE

- » holes for ventilation sleeves
- » three hinges - applies to rebated door leaf

REBATED DOOR LEAF

- » straight edge **fig. 1**
- » 2 silver screw-in pivot hinges
- » single-point mortise lock for simple key, for bathroom lock, for cylinder lock or economic lock

SLIDING SYSTEM DOOR LEAF

- » edge without rebate **fig. 2**
- » socket for hook lock and/or for handles

OPTIONS AVAILABLE WITH EXTRA CHARGE

- » door leaf „90” and „100”
- » ventilation undercut
- » double leaf door

In DUERO Natura ALU there is monochromatic, uniform, horizontal wood grain.

NOTE: The specificity of natural veneer is a possibility of differences in wood grain and staining. These differences can not be the basis of the accepted complaint.

fig. 1

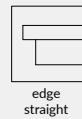
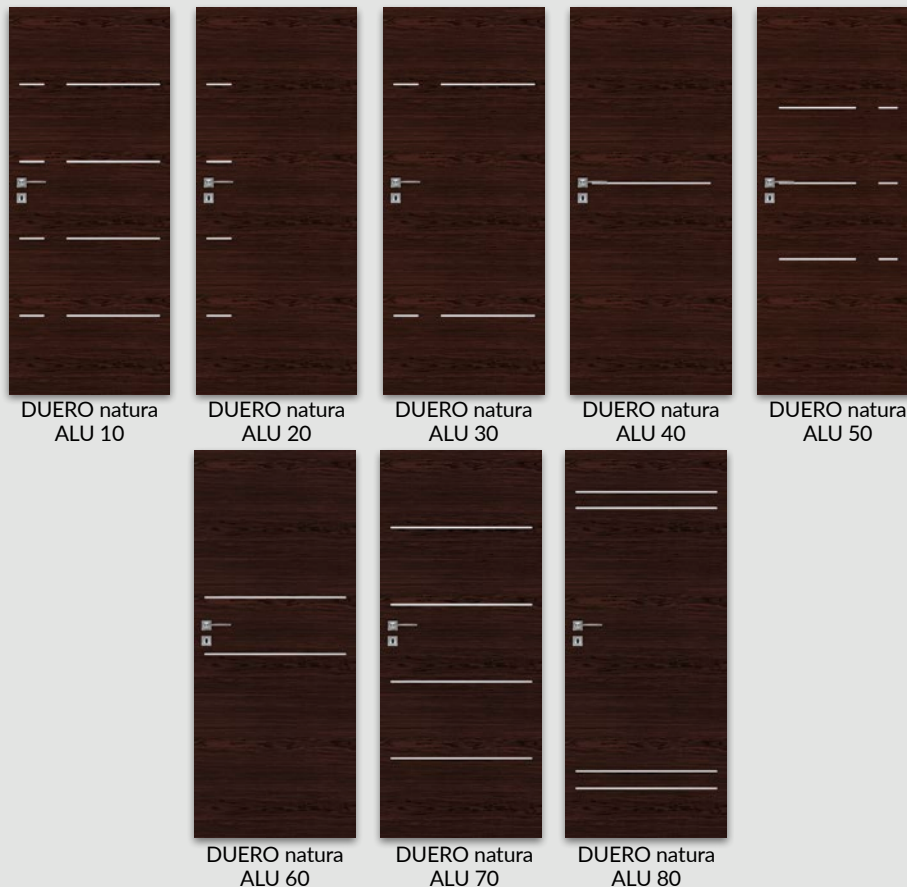

fig. 2





ARTE natura 90 - birch

veneer natural 1	 birch	 beech	 oak	
	 walnut	 wenge		
	 bleached oak	 oak light	 walnut bolivian	 dark walnut

STANDARD OPTION

- » door leaf frame made of softwood
- » core made of „honeycomb“
- » natural veneer secured with UV varnish
- » 4 mm glass pane "window blind"

OPTION WITHOUT ADDITIONAL CHARGE

- » glass pane "chinchila" or "white bark"
- » holes for ventilation sleeves
- » three hinges - applies to rebated door leaf

OPTIONS AVAILABLE WITH EXTRA CHARGE

- » glass pane MAT DRE or DECORMAT BROWN (applies to door leaf) ARTE natura 10-30, 90
ARTE natura 40, 50
ARTE natura 80
- » core made of perforated chipboard
- » door leaf „90“ and „100“
- » ventilation undercut
- » plastic ventilation grille
- » aluminum ventilation grille
- » double leaf door

NOTE: The specificity of natural veneer is a possibility of differences in wood grain and staining. These differences can not be the basis of the accepted complaint.

REBATED DOOR LEAF

- » straight edge, rounded glazing bar, **fig. 1**
- » 2 silver screw-in pivot hinges
- » single-point mortise lock for simple key, for bathroom lock, for cylinder lock or economic lock

SLIDING SYSTEM DOOR LEAF

- » edge without rebate, rounded glazing bar **fig. 2**
- » socket for hook lock and/or for handles

fig. 1

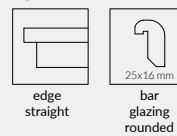
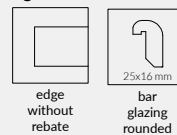

fig. 2



STANDARD natura

REBATED DOOR LEAF
interior door leaf



STANDARD OPTION

- » door leaf frame made of softwood
- » core made of „honeycomb“
- » natural veneer secured with UV varnish
- » 4 mm glass pane "window blind"

OPTION WITHOUT ADDITIONAL CHARGE

- » glass pane "chinchila" or "white bark"
- » holes for ventilation sleeves
- » three hinges - applies to rebated door leaf

NOTE: The specificity of natural veneer is a possibility of differences in wood grain and staining. These differences can not be the basis of the accepted complaint.

REBATED DOOR LEAF

- » straight edge, rounded glazing bar, **fig. 1**
- » 2 silver screw-in pivot hinges
- » single-point mortise lock for simple key, for bathroom lock, for cylinder lock or economic lock

SLIDING SYSTEM DOOR LEAF

- » edge without rebate, rounded glazing bar **fig. 2**
- » socket for hook lock and/or for handles

fig. 1

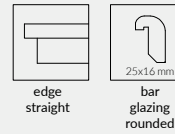
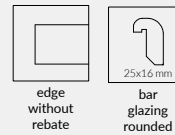

fig. 2



veneer natural 1						
	birch	beech	oak	walnut	wenge	
	veneer natural 2					
		bleached oak	oak light	walnut bolivian	dark walnut	ebony

OPTIONS AVAILABLE WITH EXTRA CHARGE

- » glass pane MAT DRE, DECORMAT BROWN or DECORMAT GRAPHITE (applies to door leaf) STANDARD natura 20, 20s, 40, 40s, BULAJ natura MDF
- » STANDARD natura 30, 30s
- » STANDARD natura 50, 50s
- » STANDARD natura 60
- » core made of perforated chipboard
- » door leaf „90” and „100”
- » rebated door leaf "110" (only STANDARD natura 10)
- » ventilation undercut
- » additional upper single point mortise lock (A) (available only in STANDARD 10 door leaf model with core made of perforated chipboard and fixed door frame)
- » plastic ventilation grille
- » aluminum ventilation grille
- » double leaf door
- » there is possibility to purchase BULAJ separately



Additional upper lock (available only in STANDARD natura 10 door leaf model with core made of perforated chipboard and fixed door frame)



steel BULAJ (available only MAT or transparent glass pane)



STANDARD natura 40s

STANDARD natura 50

STANDARD natura 50s

STANDARD natura 60

BULAJ natura MDF

BULAJ natura steel

birch	beech	oak	walnut	wenge	veneer natural 1
bleached oak	oak light	walnut bolivian	dark walnut	ebony	
					veneer natural 2

STANDARD OPTION

- » door leaf frame made of softwood
- » core made of perforated chipboard
- » natural veneer secured with UV varnish
- » 4 mm glass pane MAT DRE (in models 11,12,21,22,23,51)

OPTION WITHOUT ADDITIONAL CHARGE

- » glass pane "window blind" or decormat brown
- » holes for ventilation sleeves
- » three hinges - applies to rebated door leaf

OPTIONS AVAILABLE WITH EXTRA CHARGE

- » door leaf „90” and „100”
- » ventilation undercut
- » plastic ventilation grille
- » aluminum ventilation grille
- » double leaf door

REBATED DOOR LEAF

- » straight edge, rounded glazing bar, **fig. 1**
- » 2 silver screw-in pivot hinges
- » single-point mortise lock for simple key, for bathroom lock, for cylinder lock or economic lock

SLIDING SYSTEM DOOR LEAF

- » edge without rebate, rounded glazing bar **fig. 2**
- » socket for hook lock and/or for handles

fig. 1

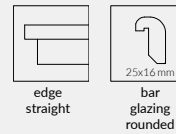
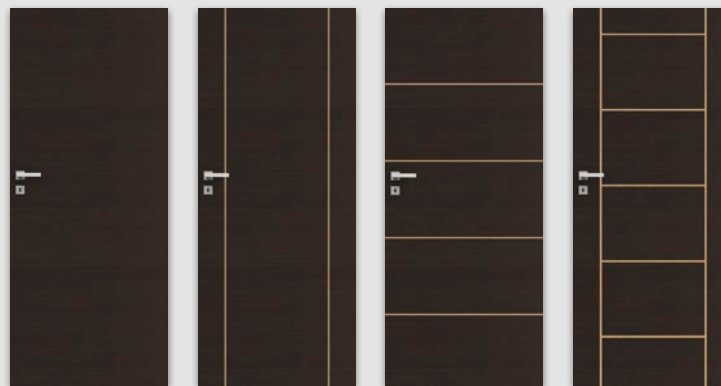
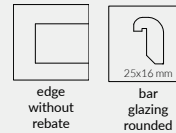

fig. 2



GALERIA
natura 02

GALERIA
natura 10

GALERIA
natura 20

GALERIA
natura 50

veneer
natural

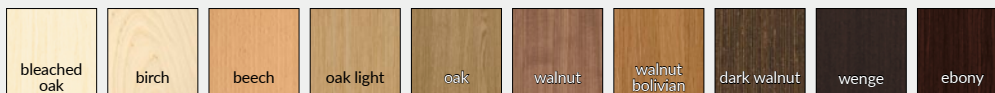

GALERIA Natura passive door leaf 20, 21, 22, 23, are made without horizontal marquetrys, and they are coated with uniform wood grain.

In sliding version of double leaf door GALERIA natura 20, 21, 22, 23, there might be noted differences in the relative positions of horizontal stripes at the corresponding heights of the leaf.

Door leaf coated with dark natural veneer have stripes in birch colour. Door leaf coated with light natural veneer have stripes in wenge colour.

NOTE: The specificity of natural veneer is a possibility of differences in wood grain and staining. These differences can not be the basis of the accepted complaint.



veneer
natural

GALERIA natura ALU

REBATED DOOR LEAF
interior door leaf



STANDARD OPTION

- » door leaf frame made of softwood
- » core made of perforated chipboard
- » natural veneer secured with UV varnish
- » aluminum marquetry elements with cross-section 8 x 2 mm
- » 4 mm glass pane MAT DRE (available in models 11-13 and 21-25)

OPTION WITHOUT ADDITIONAL CHARGE

- » glass pane "window blind" or decormat brown
- » holes for ventilation sleeves
- » three hinges - applies to rebated door leaf

REBATED DOOR LEAF

- » straight edge, rounded glazing bar, **fig. 1**
- » 2 silver screw-in pivot hinges
- » single-point mortise lock for simple key, for bathroom lock, for cylinder lock or economic lock

SLIDING SYSTEM DOOR LEAF

- » edge without rebate, rounded glazing bar **fig. 2**
- » socket for hook lock and/or for handles

OPTIONS AVAILABLE WITH EXTRA CHARGE

- » door leaf „90” and „100”
- » ventilation undercut
- » double leaf door

fig. 1

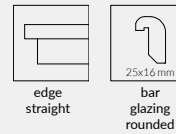
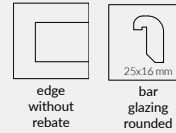

fig. 2



GALERIA natura
ALU 10

GALERIA natura
ALU 20

GALERIA natura
ALU 30

GALERIA natura
ALU 50

GALERIA natura
ALU 60

GALERIA natura
ALU 11

GALERIA natura
ALU 12

veneer
natural

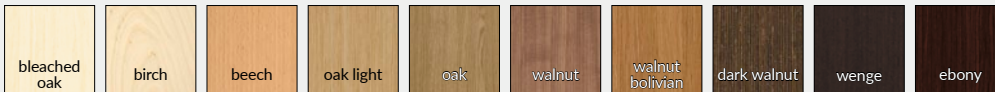

Galeria Natura Alu are coated with veneer in uniform, monochromatic wood grain.

GALERIA Natura Alu passive door leaf 20, 21, 22, 23, 24, 25 and 60 are made without horizontal marquetry, and they are coated with uniform wood grain.

In sliding version of double leaf door GALERIA Natura Alu .20, 21, 22, 23, 24, 25 i 60, there might be noted differences in the relative positions of horizontal stripes at the corresponding heights of the leaf.

NOTE: The specificity of natural veneer is a possibility of differences in wood grain and staining. These differences can not be the basis of the accepted complaint.

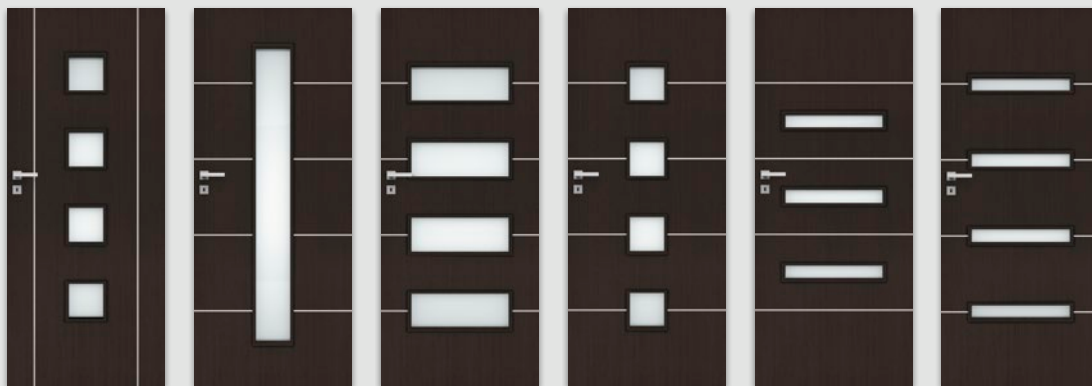

GALERIA natura
ALU 13

GALERIA natura
ALU 21

GALERIA natura
ALU 22

GALERIA natura
ALU 23

GALERIA natura
ALU 24

GALERIA natura
ALU 25

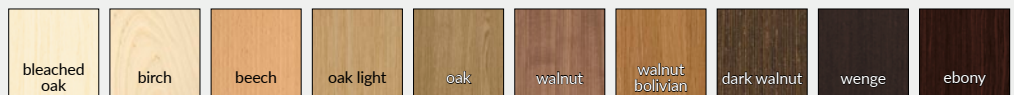

veneer
natural

STANDARD OPTION

- » door leaf frame made of softwood
- » core made of perforated chipboard
- » natural veneer secured with UV varnish

OPTION WITHOUT ADDITIONAL CHARGE

- » holes for ventilation sleeves

OPTIONS AVAILABLE WITH EXTRA CHARGE

- » door leaf „90“ and „100“
- » ventilation undercut
- » plastic ventilation grille
- » aluminum ventilation grille
- » double leaf door
- » cover-up strip for double leaf non-rebated door

Passive door leaf GALERIA Natura 20 are made without horizontal marquetrys, and they are coated with uniform wood grain.

Door leaf coated with dark natural veneer have stripes in birch colour. Door leaf coated with light natural veneer have stripes in wenge colour.

NOTE: The specificity of natural veneer is a possibility of differences in wood grain and staining. These differences can not be the basis of the accepted complaint.

NON-REBATED DOOR LEAF

- » edge without rebate **fig.1**
- » sockets for 3 hidden concealed W1078 hinges (non-rebated door frames are equipped with hinges)
- » magnetic lock for simple key, for bathroom lock, for cylinder lock or economic lock

fig. 1



GALERIA
natura 02

GALERIA
natura 10

GALERIA
natura 20

GALERIA
natura 50

veneer
natural



STANDARD OPTION

- » door leaf frame made of softwood
- » core made of „honeycomb“
- » natural veneer secured with UV varnish
- » 4 mm glass pane "window blind"

OPTION WITHOUT ADDITIONAL CHARGE

- » glass pane "chinchila" or "white bark"
- » holes for ventilation sleeves

OPTIONS AVAILABLE WITH EXTRA CHARGE

- » glass pane MAT DRE, DECORMAT BROWN or DECORMAT GRAPHITE (applies to door leaf)
- » BULAJ natura MDF
- » core made of perforated chipboard
- » door leaf „90“ and „100“
- » ventilation undercut
- » plastic ventilation grille
- » aluminum ventilation grille
- » double leaf door
- » cover-up strip for double leaf non-rebated door
- » there is possibility to purchase steel BULAJ separately

NOTE: The specificity of natural veneer is a possibility of differences in wood grain and staining. These differences can not be the basis of the accepted complaint.

NON-REBATED DOOR LEAF

- » edge without rebate **fig.1**
- » sockets for 3 hidden concealed W1078 hinges (non-rebated door frames are equipped with hinges)
- » magnetic lock for simple key, for bathroom lock, for cylinder lock or economic lock

fig. 1



edge without rebate

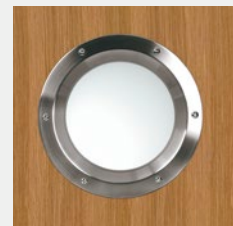

steel BULAJ (available only MAT or transparent glass pane)



STANDARD natura 10

BULAJ natura MDF

BULAJ steel natura

BOLIVIAN WALNUT





GALERIA natura ALU 20 non-rebated wenge

veneer
natural



STANDARD OPTION

- » door leaf frame made of softwood
- » core made of perforated chipboard
- » natural veneer secured with UV varnish
- » aluminium marquetry elements with cross-section 8x2 mm

OPTION WITHOUT ADDITIONAL CHARGE

- » holes for ventilation sleeves

OPTIONS AVAILABLE WITH EXTRA CHARGE

- » door leaf „90“ and „100“
- » ventilation undercut
- » double leaf door
- » cover-up strip for double leaf non-rebated door

Galeria Natura Alu are coated with veneer in uniform, monochromatic wood grain.

GALERIA Natura Alu door leaf 20 and 60 are made without horizontal marquetrys, and they are coated with uniform wood grain.

NOTE: The specificity of natural veneer is a possibility of differences in wood grain and staining. These differences can not be the basis of the accepted complaint.

NON-REBATED DOOR LEAF

- » edge without rebate **fig.1**
- » sockets for 3 hidden concealed W1078 hinges (non-rebated door frames are equipped with hinges)
- » magnetic lock for simple key, for bathroom lock, for cylinder lock or economic lock

fig. 1





DUO 10 - white/ ebony

Decor

white acrylic
lacquer UV
door leaf
surface

Decor
DRE-Cell

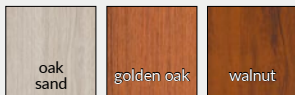

Decor 3D

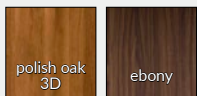

STANDARD OPTION

- » Door leaf surface painted with white acrylic varnish with strengthened resistance to abrasion
- » door leaf frame made of MDF
- » core made of „honeycomb“
- » glass pane MAT DRE 4 mm thick

OPTION WITHOUT ADDITIONAL CHARGE

- » white ventilation sleeves
- » three hinges applies to rebated door leaf

OPTIONS AVAILABLE WITH EXTRA CHARGE

- » core made of perforated chipboard
- » door leaf „90“ and „100“
- » ventilation undercut
- » plastic ventilation grille

REBATED DOOR LEAF

- » "karnies" edge, rounded glazing bar fig.1
- » 2 silver screw-in pivot hinges
- » single-point mortise lock for simple key, for bathroom lock, for cylinder lock or economic lock

NOTE: Door leaf surface is painted in white, selected colour applies to glazing bars and door leaf edge. It is recommended to order door frame in this selected colour.

fig. 1

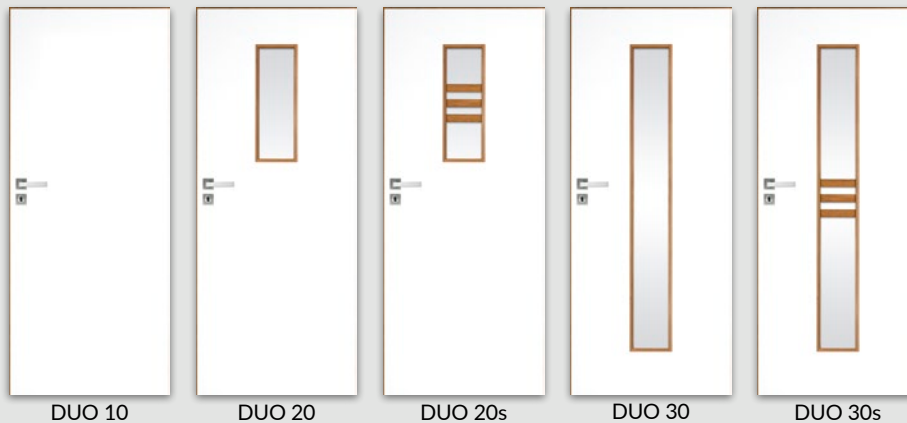
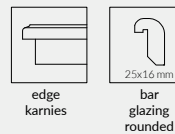



UNI 10 - ashen

Decor



white water based UV varnish - RAL 9003
ecru - RAL 9001
latte - Flugger 4362, NCS S1505-Y50R
ashen - RAL 7035

STANDARD OPTION

- » door leaf painted with water-based UV varnish
- » door leaf frame made of softwood
- » core made of „honeycomb“
- » glass pane white bark 4 mm thick

OPTION WITHOUT ADDITIONAL CHARGE

- » glass pane „chinchila“ or „window blind“
- » ventilation sleeves
- » three hinges - applies to rebated door leaf

REBATED DOOR LEAF

- » straight edge **fig. 1**
- » 2 silver screw-in pivot hinges
- » single-point mortise lock for simple key, for bathroom lock, for cylinder lock or economic lock

NON-REBATED DOOR LEAF (extra charge)

- » edge without rebate **fig. 2**
- » sockets for 3 hidden concealed W1078 hinges (non-rebated door frames are equipped with hinges)
- » magnetic lock for simple key, for bathroom lock, for cylinder lock or economic lock

SLIDING SYSTEM DOOR LEAF

- » edge without rebate **fig. 2**
- » socket for hook lock and/or for handles

OPTIONS AVAILABLE WITH EXTRA CHARGE

- » glass pane MAT DRE, DECORMAT BROWN, DECORMAT GRAPHITE (applies to door leaf BULAJ MDF)
- » core made of perforated chipboard
- » door leaf „90“ and „100“
- » ventilation undercut
- » non-rebated door leaf
- » cover-up strip for double leaf non-rebated door
- » plastic ventilation grille
- » aluminum ventilation grille
- » double leaf door
- » there is possibility to purchase steel BULAJ separately

fig. 1

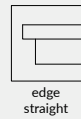
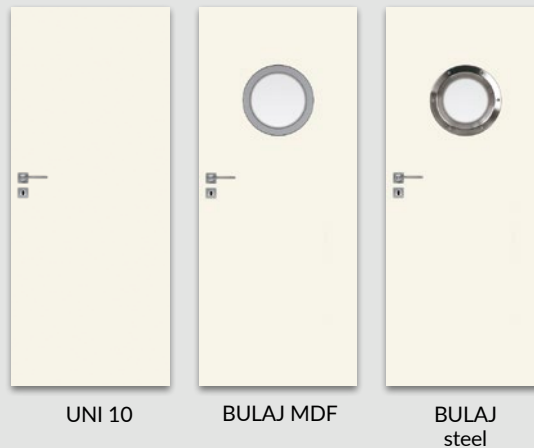

fig. 2



steel BULAJ
(available only MAT or transparent glass pane)



UNI 10

BULAJ MDF

BULAJ
steel



BINITO 23 white

Decor

white water based UV varnish	ecru	latte	ashen
------------------------------	------	-------	-------

white water based UV varnish - RAL 9003
ecru - RAL 9001
latte - Flugger 4362, NCS S1505-Y50R
ashen - RAL 7035

STANDARD OPTION

- » door leaf painted with water-based UV varnish
- » door leaf frame made of softwood
- » core made of „honeycomb”
- » glass pane white bark 4 mm thick

OPTION WITHOUT ADDITIONAL CHARGE

- » glass pane „chinchila” or „window blind”
- » ventilation sleeves
- » three hinges - applies to rebated door leaf

NOTE: To ensure highest quality of painted products, before painting process, both, door leaf and door frames are coated with special material which constitutes solid base.

OPTIONS AVAILABLE WITH EXTRA CHARGE

- » glass pane MAT DRE, DECORMAT BROWN, DECORMAT GRAPHITE BINITO 11, 23 BINITO 21 BINITO 24
- » door leaf „90” and „100”
- » core made of perforated chipboard
- » ventilation undercut
- » non-rebated door leaf
- » cover-up strip for double leaf non-rebated door
- » plastic ventilation grille
- » aluminum ventilation grille
- » double leaf door

REBATED DOOR LEAF

- » straight edge, flat glazing bar **fig. 1**
- » 2 silver screw-in pivot hinges
- » single-point mortise lock for simple key, for bathroom lock, for cylinder lock or economic lock

NON-REBATED DOOR LEAF (extra charge)

- » edge without rebate, flat glazing bar **fig. 2**
- » sockets for 3 hidden concealed W1078 hinges (non-rebated door frames are equipped with hinges)
- » magnetic lock for simple key, for bathroom lock, for cylinder lock or economic lock

SLIDING SYSTEM DOOR LEAF

- » edge without rebate, flat glazing bar **fig. 2**
- » socket for hook lock and/or for handles

fig. 1

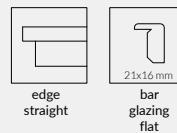
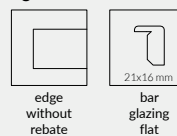
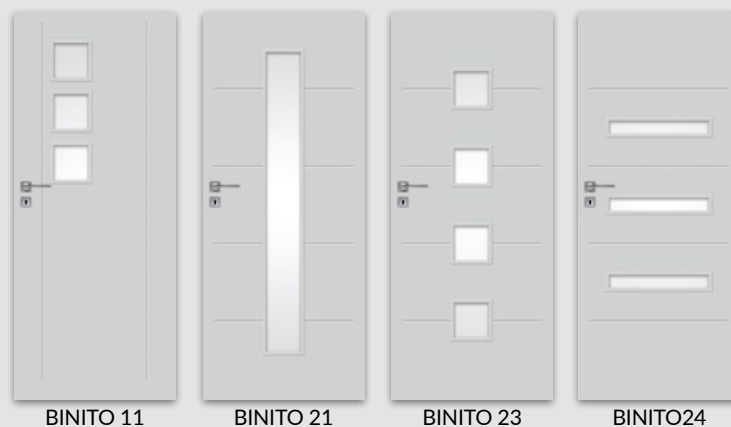
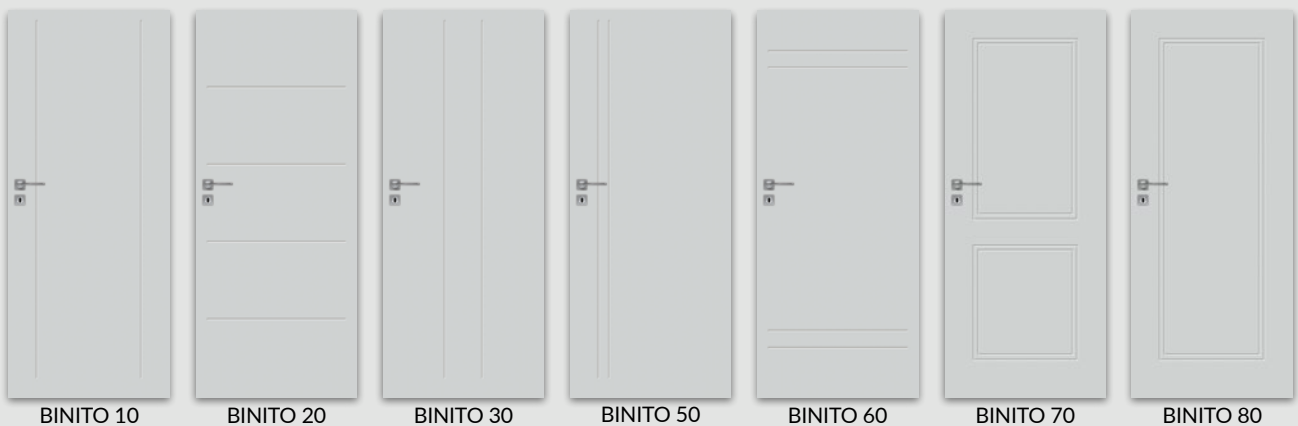

fig. 2



types of milling in BINITO collection



STANDARD CPL

REBATED DOOR LEAF
interior door leaf



STANDARD OPTION

- » edge with radius R 2,5 mm
- » door leaf frame made of softwood
- » core made of „honeycomb”
- » glass pane white bark 4 mm thick
- » CPL laminate 0,15 - 0,2 mm or 0,7 - 0,8 mm thick

OPTION WITHOUT ADDITIONAL CHARGE

- » glass pane „chinchila” or „window blind”
- » ventilation sleeves
- » three hinges applies to rebated door leaf

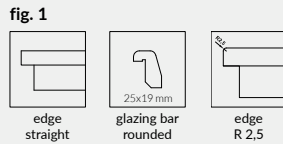

REBATED DOOR LEAF

- » straight edge coated with edge band 1,5 mm thick or edge with radius R 2,5 mm finished with method of directforming fig. 1
- » 2 silver screw-in pivot hinges
- » single-point mortise lock for simple key, for bathroom lock, for cylinder lock or economic lock

NOTE: colours equivalent
W0118 - WHITE
LIGHT GRAY; RAL=7047
DARK GRAY

OPTIONS AVAILABLE WITH EXTRA CHARGE

- » straight edge coated with edge band 1,5 mm thick
- » glass pane MAT DRE, DECORMAT BROWN, DECORMAT GRAPHITE (applies to door leaf) STANDARD 20, BULAJ MDF STANDARD 60
- » core made of perforated chipboard
- » door leaf „90” and „100”
- » door leaf „110” (available only in STANDARD 10)
- » Additional upper single point mortise lock (available only in STANDARD 10 door leaf model with core made of perforated chipboard and fixed door frame)
- » plastic ventilation grille
- » aluminum ventilation grille
- » ventilation undercut
- » double leaf door
- » there is possibility to purchase BULAJ separately

There is available 0,7 - 0,8 mm CPL laminate- to place an order and for more information please contact Customer Service Department.



additional upper single point mortise lock
(available only in STANDARD 10 door leaf model with core made of perforated chipboard and fixed door frame)

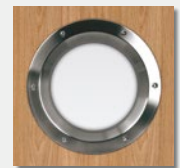

steel BULAJ
(available only MAT or transparent glass pane)

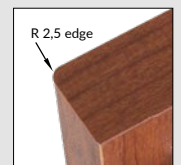

edge R 2,5 mm

Laminate
CPL



STANDARD OPTION

- » door leaf frame made of softwood
- » core made of „honeycomb“

OPTION WITHOUT ADDITIONAL CHARGE

- » ventilation sleeves

REBATED DOOR LEAF

- » straight edge coated with edge banding or edge with profile R 2,5 mm made in method of directforming **fig. 1**
- » 3 silver screw-in pivot hinges
- » single-point mortise lock for simple key, for bathroom lock, for cylinder lock or economic lock

NON-REBATED DOOR LEAF (extra charge)

- » edge without rebate **fig. 2**
- » sockets for 3 hidden concealed W1078 hinges (non-rebated door frames are equipped with hinges)
- » magnetic lock for simple key, for bathroom lock, for cylinder lock or economic lock

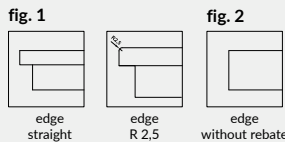

OPTIONS AVAILABLE WITH EXTRA CHARGE

- » straight edge and edge without rebate in CPL laminate is coated with edgeband 1,5 mm thick
- » core made of: perforated chipboard (1983)
- » perforated chipboard (2110 and 2240)
- » door leaf "90" and "100" (1983)
- » door leaf "90" and "100"(2110 and 2240)
- » non-rebated door leaf
- » ventilation undercut
- » plastic ventilation grille
- » aluminum ventilation grille
- » cover-up strip for double leaf non-rebated door
- » double leaf door

There is available 0,7 - 0,8 mm CPL laminate- to place an order and for more information please contact Customer Service Department.

Door leaf, dependent on selected height option - 1983 mm, 2110 mm or 2240 is dedicated to door frames with three hinges in corresponding heights.

NOTE: colours equivalent
W0118 - WHITE
LIGHT GRAY; RAL=7047
DARK GRAY

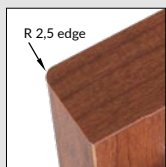

edge R 2,5 mm in CPL laminate



*** decor available only in horizontal wood grain

							white (structure)	ash	beech	alder	golden oak	calvados	walnut	Decor DRE-Cell 1
white mat	white pine	elm siberian	silver	oak sand	bleached oak textured	vintage oak	walnut caramel	golden oak textured	walnut dark textured	gray oak textured***	elm tabac	elm anthracite	wenge dark	Decor DRE-Cell 2
white	white noble VVF7206	light gray	gray dark	concrete 1 F6462	gray oak	welsh oak	acacia	celini walnut	walnut	honey oak	chestnut	roasted walnut	Laminate CPL	

MODERN

REBATED AND NON-REBATED DOOR LEAF WITH DIFFERENT HEIGHT
interior door leaf



STANDARD OPTION

- » door leaf frame made of softwood
- » core made of „honeycomb“
- » glass pane white bark 4 mm thick

OPTION WITHOUT ADDITIONAL CHARGE

- » glass pane „chinchila“ or „window blind“
- » ventilation sleeves

REBATED DOOR LEAF

- » straight edge, flat glazing bar (in CPL laminate - rounded glazing bar) flat 4 mm HDF panels **fig. 1**
- » 3 silver screw-in pivot hinges
- » single-point mortise lock for simple key, for bathroom lock, for cylinder lock or economic lock

NON-REBATED DOOR LEAF (EXTRA CHARGE)

- » edge without rebate, flat glazing bar (in CPL - rounded glazing bar), flat 4 mm HDF panels **fig. 2**
- » sockets for 3 hidden concealed W1078 hinges (non-rebated door frames are equipped with hinges)
- » magnetic lock for simple key, for bathroom lock, for cylinder lock or economic lock

NOTE: colours equivalent
W0118 - WHITE
LIGHT GRAY; RAL=7047
DARK GRAY

OPTIONS AVAILABLE WITH EXTRA CHARGE

- » straight edge and edge without rebate in CPL laminate is coated with edgeband 1,5 mm thick
- » glass pane MAT DRE, DECORMAT BROWN, DECORMAT GRAPHITE (applies to door leaf) MODERN 20 MODERN 30 MODERN 40 MODERN 50
- » core made of: perforated chipboard (1983 and 2043) perforated chipboard (2110 and 2240)
- » door leaf „90“ and „100“ (1983 and 2043)
- » door leaf "90" and "100"(2110 and 2240)
- » non-rebated door leaf
- » ventilation undercut
- » plastic ventilation grille
- » aluminum ventilation grille
- » cover-up strip for double leaf non-rebated door
- » double leaf door

NOTE: Different heights are available in all models of MODERN collection.

Door leaf, dependent on selected height option - 1983mm, 2110mm or 2240mm is dedicted to door frames with three hinges in corresponding heights.

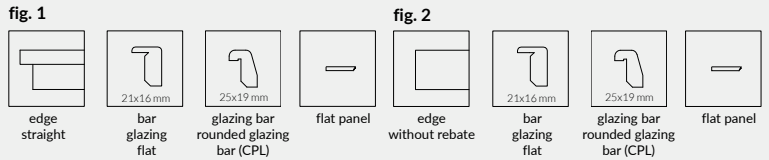

NOTE: In rebated door leaf coated with CPL laminate there is possible to choose door leaf with edge with radius R=2.5 mm.



Decor DRE-Cell 1	white (structure)	ash	beech	alder	golden oak	calvados	walnut							
								*** decor available only in horizontal wood grain						
Decor DRE-Cell 2	white mat	white pine	elm siberian	silver	oak sand	bleached oak textured	vintage oak	walnut caramel	golden oak textured	walnut dark textured	gray oak textured**	elm tabac	elm anthracite	wenge dark
	Laminate CPL	white	white noble VVF7206	light gray	gray dark	concrete 1 F6462	gray oak	welsh oak	acacia	celini walnut	walnut	honey oak	chestnut	roasted walnut

STANDARD OPTION

- » door leaf frame made of softwood
- » core made of „honeycomb”
- » glass pane white bark 4 mm thick

OPTION WITHOUT ADDITIONAL CHARGE

- » glass pane „chinchila” or „window blind”
- » ventilation sleeves

REBATED DOOR LEAF

- » straight edge, flat glazing bar (in CPL laminate - rounded glazing bar) flat 4 mm HDF panels **fig. 1**
- » 3 silver screw-in pivot hinges
- » single-point mortise lock for simple key, for bathroom lock, for cylinder lock or economic lock

NON-REBATED DOOR LEAF (extra charge)

- » edge without rebate, flat glazing bar (in CPL laminate - rounded glazing bar), flat 4mm HDF panels **fig. 2**
- » sockets for 3 hidden concealed W1078 hinges (non-rebated door frames are equipped with hinges)
- » magnetic lock for simple key, for bathroom lock, for cylinder lock or economic lock

NOTE: colours equivalent
W0118 - WHITE
LIGHT GRAY; RAL=7047
DARK GRAY

NOTE: In rebated door leaf coated with CPL laminate there is possible to choose door leaf with edge with radius R=2.5 mm.

OPTIONS AVAILABLE WITH EXTRA CHARGE

- » straight edge and edge without rebate in CPL laminate is coated with edgeband 1,5 mm thick
- » glass pane MAT DRE, DECORMAT BROWN, DECORMAT GRAPHITE (applies to door leaf) PLUS 20 PLUS 40, 50, 60, 70, 80 PLUS 30
- » core made of: perforated chipboard (1983 and 2043) perforated chipboard (2110 and 2240)
- » door leaf „90” and „100” (1983 and 2043)
- » door leaf “90” and “100”(2110 and 2240)
- » non-rebated door leaf
- » ventilation undercut
- » plastic ventilation grille
- » aluminum ventilation grille
- » cover-up strip for double leaf non-rebated door
- » double leaf door

NOTE: Different heights are available in all models of PLUS collection.

Door leaf, dependent on selected height option - 1983mm, 2110mm or 2240mm is dedicted to door frames with three hinges in corresponding heights.

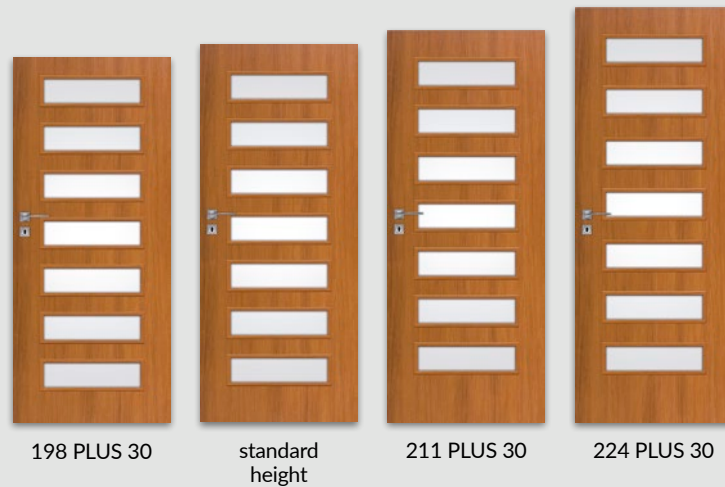
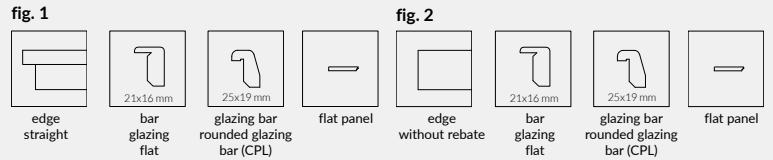

*** decor available only in horizontal wood grain

							white (structure)	ash	beech	alder	golden oak	calvados	walnut	Decor DRE-Cell 1
white mat	white pine	elm siberian	silver	oak sand	bleached oak textured	vintage oak	walnut caramel	golden oak textured	walnut dark textured	gray oak textured	elm tabac	elm anthracite	wenge dark	Decor DRE-Cell 2
	white	white noble VVF7206	light gray	gray dark	concrete 1 F6462	gray oak	welsh oak	acacia	celini walnut	walnut	honey oak	chestnut	roasted walnut	Laminate CPL



ENA - white mat

DRE sliding system is designed to be used together in one set with single or double leaf interior door, which are available in our sale offer in sliding version. Sliding system is available in veneer colours which constitute standard finishing colours of door leaf unit: DRE - Cell, 3D foil, natural veneers and painted doors with the exception of the following collections: Enter, Enter Natura, Solid, Solid RC2, Vetro C, Lack, Ascada, Sinco, Ivi, Duo, Rim, fire resistnace doors, glass doors and doors with different heights.

In our sale offer there are available two different types of sliding system:

NS - system mounted directly on the wall

NT - sliding system mounted together with adjustable tunnel

There are two options of NT sliding system:

- » mounted together with adjustable tunnel with 63 mm architrave
- » mounted together with adjustable tunnel with 80 mm architrave

Set of sliding system comprises of: sliding guide bar with hardware (LEON SN 150, 180, 200), spacing board, masking strip, and fender beam (fender beam is available for single leaf - for doors with hook lock option in fender beam there is milling for latch).

In the system mounted with adjustable tunnel NT set contains 2 additional 16 mm spacing boards with cross-sections adapted to the width of architraves (63 mm or 80 mm). There are differences in cross-sections of NS and NT masking element.

To complete entire set of sliding doors it is necessary to purchase sliding leaf unit in following dimensions:

Single leaf door: „60“, „70“, „80“, „90“, „100“

Double leaf door: „2x60“, „2x70“, „2x80“, „2x90“, „2x100“

Door leaf might be equipped with sockets for lock and/or handle - those accessories must be purchased separately.

In the system mounted with adjustable tunnel NT, it is necessary to purchase adjustable tunnel separately.

SLIDING SYSTEM

WALL MOUNTED SLIDING SYSTEM

ACCESSORIES

- » round handle 1 pcs.
- » oval handle 1 pcs.
- » hook lock with two round or oval handles with key

One set of door handle for single door leaf consist of 2 pcs.



hook lock with round handle hook lock with oval handle

masking strip with guide bar

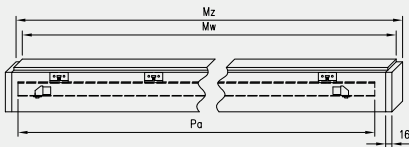

Masking strip and guide bar for double sliding system is made by connecting two elements of single system.

Single sliding system

Dimension door [mm]	Masking strip		Guide bar
	Mz	Mw	Pa
644, 744	1620	1588	1500
844	1920	1888	1800
944	2120	2088	2000
1044	2140	2108	2000

double leaf sliding system

Dimension door [mm]	Masking strip		Guide bar
	Mz	Mw	Pa
2 x 644	2 x 1519	2 x 1503	2 x 1500
2 x 744	2 x 1519	2 x 1503	2 x 1500
2 x 844	2 x 1819	2 x 1803	2 x 1800
2 x 944	2 x 2019	2 x 2003	2 x 2000
2 x 1044	2 x 2063	2 x 2047	2 x 2000

NS - vertical cross-section

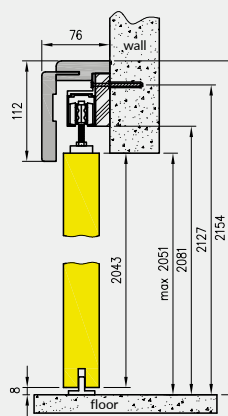

NT - vertical cross-section for tunnel with 63 mm architrave

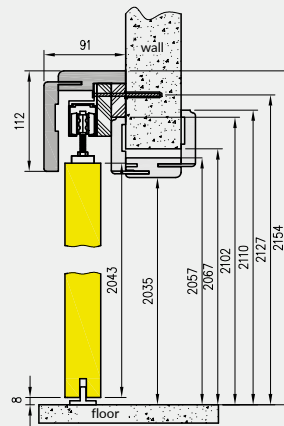

NT - vertical cross-section for tunnel with 80 mm architrave

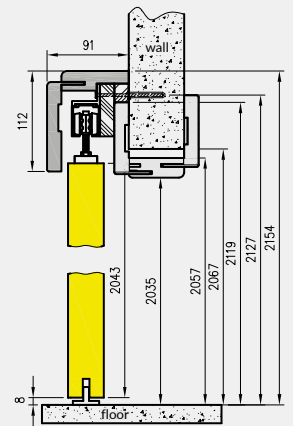

Single sliding system

symbol	„60”	„70”	„80”	„90”	„100”
A	600	700	800	900	1000
C	644	744	844	944	1044
D	664	764	864	964	1064
E	750	850	950	1050	1150
E*	784	884	984	1084	1184
S	644	744	844	944	1044

double leaf sliding system

symbol	„120”	„140”	„160”	„180”	„200”
A	1200	1400	1600	1800	2000
C	1244	1444	1644	1844	2044
D	1264	1464	1664	1864	2064
E	1350	1550	1750	1950	2150
E*	1384	1584	1784	1984	2184
S**	644	744	844	944	1044

E* applies to tunnel with T80 architrave
S** width of single door leaf

Height of sliding door leaf unit - 2043 mm
total height of sliding system - 2154 mm

NS - horizontal cross-section (left system)

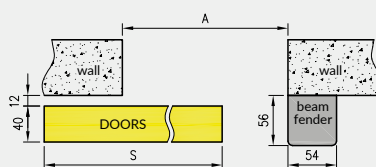

NT - horizontal cross-section (left system)

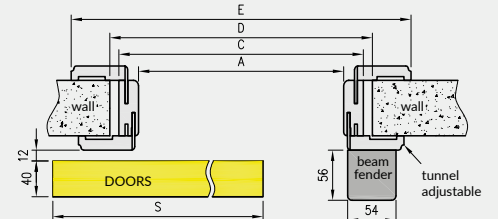

* is not available in double leaf system

NOTE: In double sliding system masking strip is connected on length, by two single elements.



GOSSA 4 - sliding system glass doors

Sliding system for glass doors "Spazio", is made of anodized aluminum, and used as a complete and complementary solution together with finished door frame. Whole set comprises of - guide channel with straight or oval blende, hardware designed to hang sliding glass pane and bottom door guide.

There is two options of Spazio System (only difference is in the shape of external blende):

- » Spazio TP - with straight blende
- » Spazio TO - with oval blende

PRICE

- » price of sliding system for a glass doors

To complete the whole system it is recommended to buy glass door leaf in sliding version form one of our collections: Galla, Gracca or Gossa. There is designed for this solution round handle.

OPTIONS AVAILABLE WITH EXTRA CHARGE

- » door handle (two-sided)



door handle
(stainless steel)

Note: There is no possibility to make ventilation option.

sliding glass door leaf

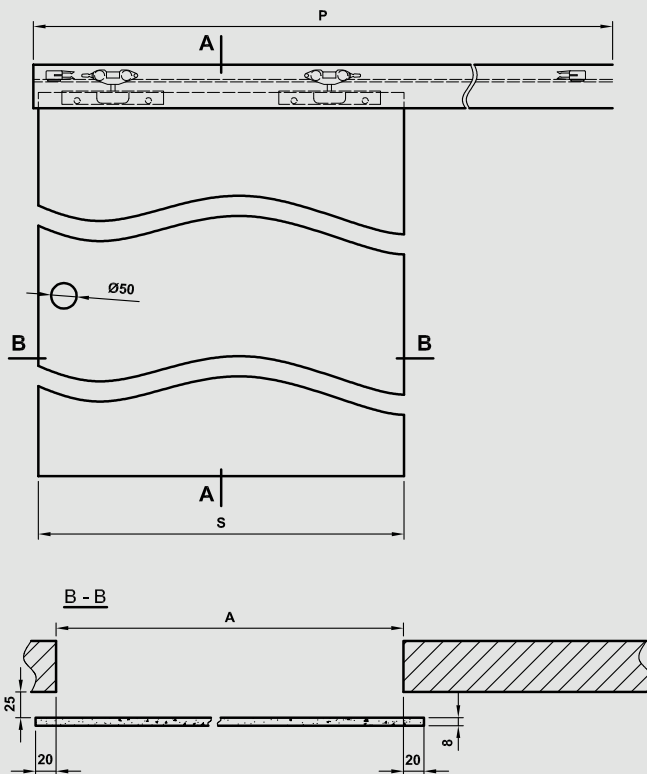
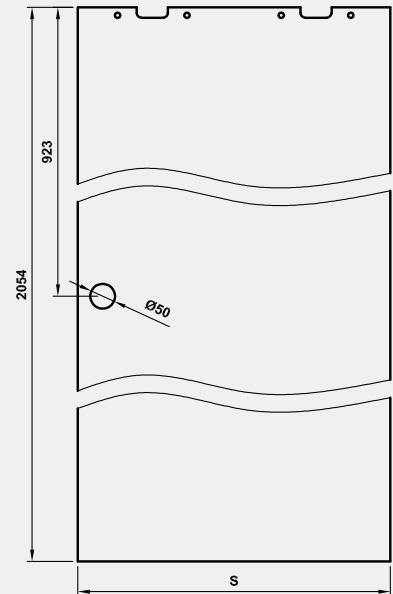

A - A vertical cross-section of Spazio TP

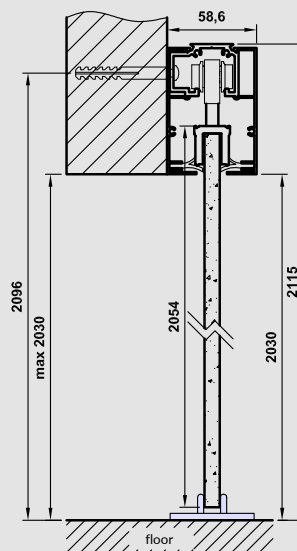

A - A vertical cross-section of Spazio TO

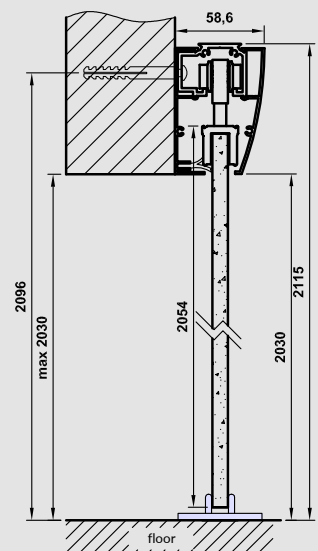

Dimensions

	S	A	P
„60”	630	590	1340
„70”	730	690	1540
„80”	830	790	1740
„90”	930	890	1940

S - width of door leaf unit
A - width of wall passage
P - length of guide channel



Sliding system SPAZIO CD - STANDARD 10 sand oak

SLIDING SYSTEM SPAZIO CD MOUNTED ON-WALL

SLIDING SYSTEM DOOR LEAF
interior door leaf

SPAZIO CD

On-wall mounted sliding system with anodized guide channel and rectangular blende. Is designated for panel doors and frame construction doors.

WHOLE SET COMPRISES OF:

- » guide channel with side caps
- » system sliding trolleys
- » door leaf hangers
- » bottom stopper
- » assembly kit (screws and bolts)

To complete the whole system it is recommended to buy door leaf in sliding system version available in our standard sale offer together with door handle. Door handle is to be purchased separately (informations pp. 111).

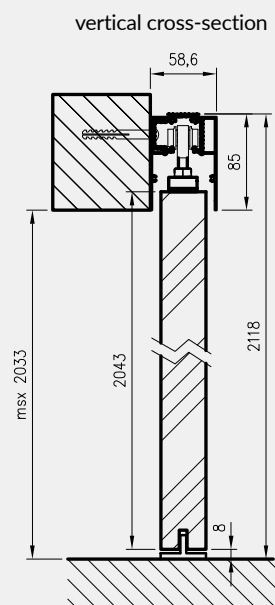
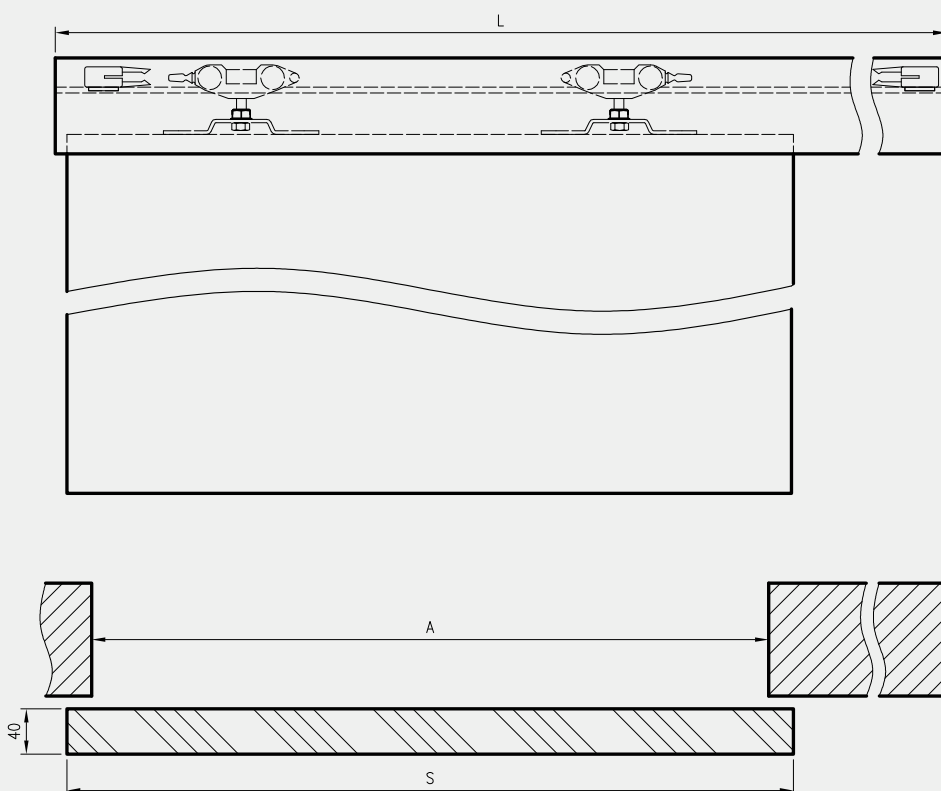

	A	S	L
„60”	600	644	1300
„70”	700	744	1500
„80”	800	844	1700
„90”	900	944	1900
„100”	1000	1044	2100

A - width of wall passage
S - width of door leaf unit
L - length of guide channel



Sliding system doors hidden in the wall (pocket system) PA - STANDARD 10 vintage oak

Decor DRE-Cell	white (structure)	white mat	white pine	elm siberian	silver	vanilla***	ash	beech	vintage oak	oak sand	bleached oak textured	alder	golden oak
	calvados	walnut	walnut caramel	golden oak textured	walnut dark textured	gray oak textured***	elm tabac	elm anthracite	wenge dark				
Decor 3D	grand oak	elm	walnut american	ebony	polish oak 3D								

*** decor available only in horizontal wood grain

SLIDING SYSTEM DOORS HIDDEN IN THE WALL (POCKET SYSTEM)

SLIDING SYSTEM DOOR LEAF
interior door leaf

SLIDING SYSTEM DOORS HIDDEN IN THE WALL (POCKET SYSTEM) PA - 125 MM

Sliding system doors hidden in the wall (pocket system) PA - it is sliding system doors hidden in the wall designated for light gypsum cardboard wall construction.

TECHNICAL PARAMETERS:

Assembly of sliding system doors hidden in the wall is to be done in construction of the profiles used to build gypsum cardboard wall construction with total thickness 125 mm (or other type of the construction with total thickness 125 mm). After it is necessary to finish wide surfaces with plasterboards 12,5 mm thick (plasterboards shall be purchased separately), finish detailing process of those surfaces and assemble tunnel cover of sliding system .

SET COMPRISES OF:

- » cassette elements made of aluminum elements and additional assembly accessories
- » elements which allows to decorate build in sliding system - so called tunnel cassette cover with architraves 80 mm wide

To complete whole system it is necessary to purchase door leaf in sliding system (it is recommended to purchase door leaf with "thimble" option) and hardware for this door leaf (lock and/or door handle and thimble).

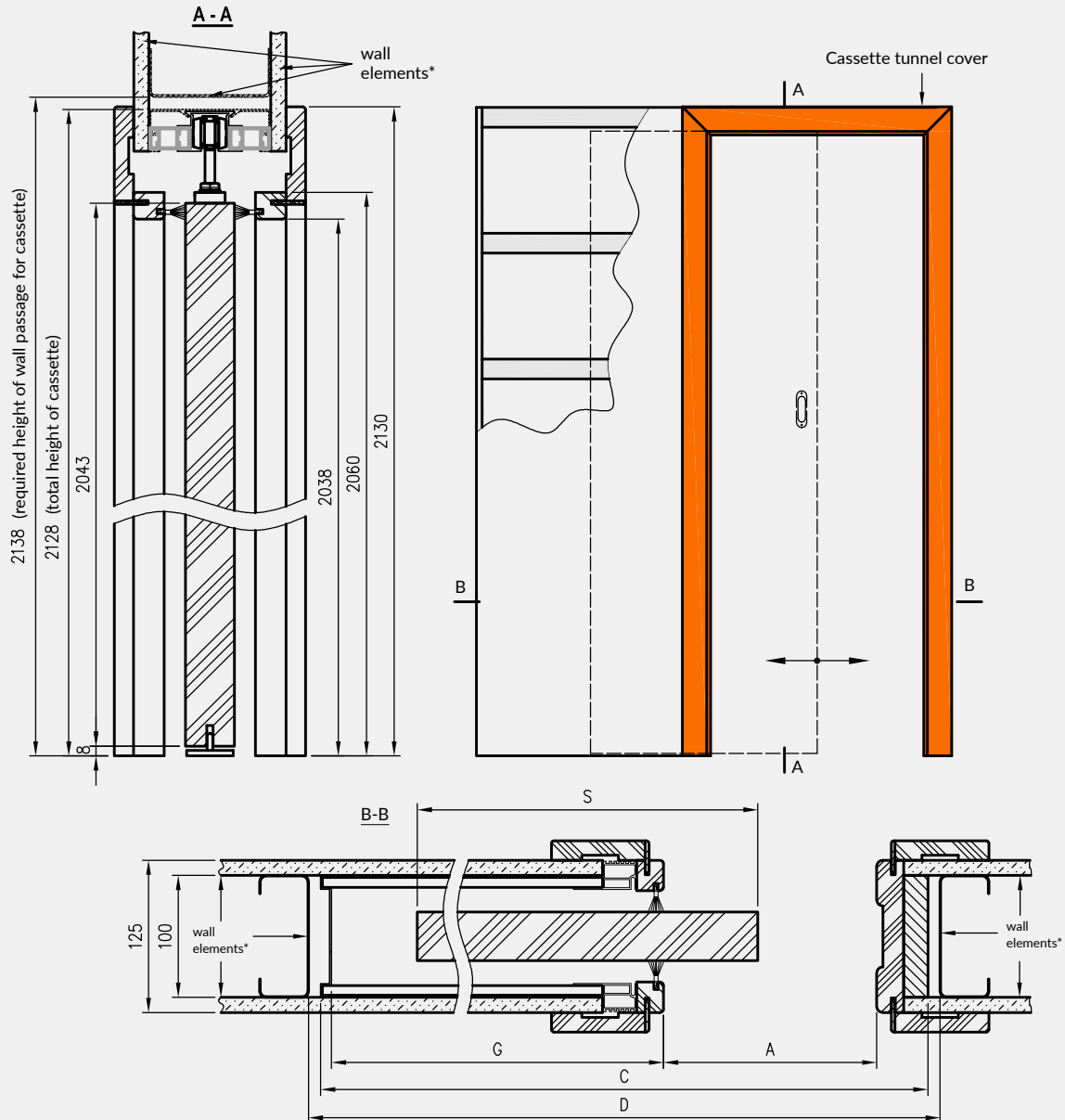

	A	S	C	D	G
60	600	644	1310	1330	659
70	700	744	1510	1530	759
80	800	844	1710	1730	859
90	900	944	1910	1930	959
100	1000	1044	2110	2130	1059

C - total width of cassette
D - width of walls passage prepared for cassette
G - depth of ready cassette



folding doors FOLDE 10 - white matt

Decor DRE-Cell 1	white (structure)	ash	beech	alder	golden oak	calvados	walnut											
Decor DRE-Cell 2	white mat	white pine	elm siberian	silver	oak sand	bleached oak textured	vintage oak	walnut caramel	golden oak textured	dark walnut textured	gray oak textured	elm tabac	elm anthracite	wenge dark				
Decor 3D	grand oak	elm	walnut american	ebony	polish oak 3D													

*** decor available only in horizontal wood grain

System of folding doors is characterised by that, during opening process of door leaf unit, doors fold into position parallel to each other.

The complete set of folding doors comprises:

- » two-element door leaf interconnected by 3 hidden concealed hinges
- » adjustable door frame for folding doors

STANDARD OPTION

- » door leaf frame made of softwood
- » core made of „honeycomb”
- » straight edge **fig. 1**
- » single-point mortise lock for simple key, for bathroom lock, for cylinder lock or economic lock
- » 3 hidden concealed ISTAR hinges instaled between two-element door leaf unit

fig. 1

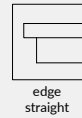

OPTIONS AVAILABLE WITH EXTRA CHARGE

- » core made of perforated chipboard
- » door leaf „90” and „100”

Cross-section of folding doors in closed position*
(right doors, left doors it is mirror reflection)

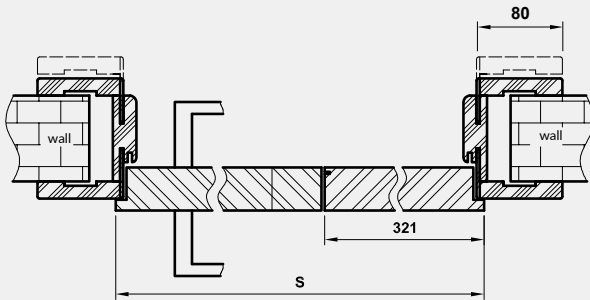

Cross-section of folding doors
in opened position*

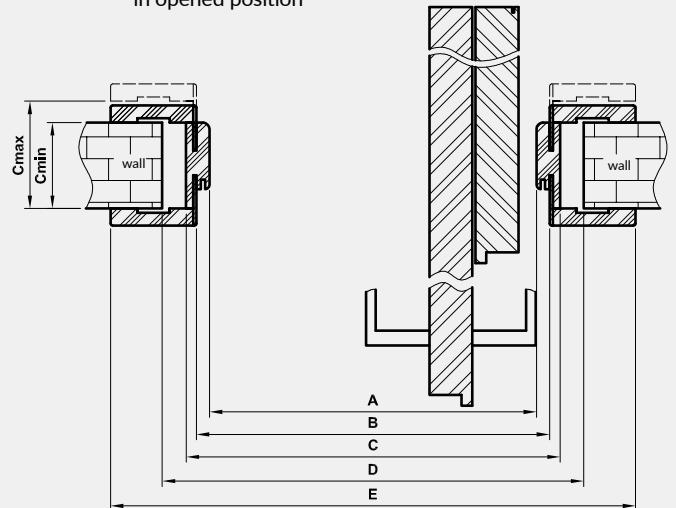

Dimensions

	S	A	B	C	D	E
„80”	844	806	830	850	880	990
„90”	944	906	930	950	980	1090
„100”	1044	1006	1030	1050	1080	1190

D - required width of wall passage

NOTE: There is no possibility to shorten door leaf.

*NOTE: When doors are fully opened, the door fittings slightly reduce the clear opening by approx. 10 cm. (this value doesn't take into account door handle)

vertical cross-section

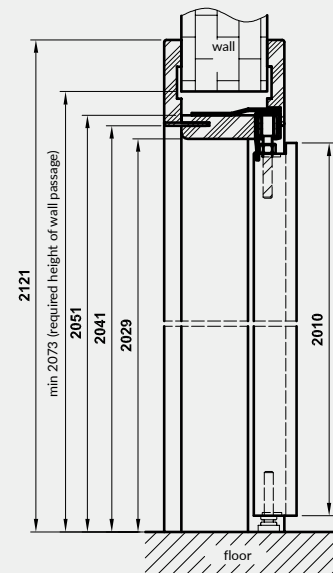



Sara Eco

Decor DRE-Cell	white (structure)	white mat*	white pine	elm siberian	silver	oak sand	bleached oak textured	vintage oak	ash	beech	alder	golden oak	calvados
	walnut caramel	golden oak textured	walnut	walnut dark textured	gray oak textured***	elm tabac	elm anthracite	wenge dark					
Decor 3D	grand oak	elm	walnut american	ebony	polish oak 3D								
Decor	primed												
Decor painted	white water based UV varnish	ecru	latte	ashen									

white water based UV varnish - RAL 9003
 ecru - RAL 9001
 latte - Flugger 4362, NCS S1505-Y50R
 ashen - RAL 7035

NON-REBATED DOOR LEAF - OPENED OUTWARDS

Sara Eco door leaf is an innovative solution for creative interior design with the use of "invisible" doors. This unique construction gives possibility to finish surface of door leaf in the colours of the walls.

CONSTRUCTION OF SARA ECO DOOR LEAF COMPRISES OF:

Aluminum door frame, "invisible" after assembly process, build in the wall or overlaid with sheets of plaster board. After detailing process, only visible part is rebate of the door frame, prepared for future painting, e.q. in the colours of the walls.

non- rebated panel construction door leaf is available in two finishing options:

- » wide surfaces of door leaf are primed and ready for painting or paperhanging (e.q. in the colour of the walls). Edges of the leaf are covered with a paintable edge band. Painting is to be done at one-s discretion or optional choose painted decor.
- » wide surfaces of door leaf are coated with veneer from DRE - Cell or 3D group, while the edges of the leaf are covered with a edge band in the colour of the veneer.

OPTIONS AVAILABLE WITH EXTRA CHARGE WITH PRIMER

- » ventilation undercut

STANDARD OPTION

- » door leaf frame made of softwood
- » sockets for 2 hidden concealed ISTAR hinges
- » core made of „honeycomb“
- » magnetic lock for simple key, for bathroom lock, for cylinder lock or economic lock

OPTIONS AVAILABLE WITH EXTRA CHARGE IN DRE-CELL, 3D AND PAINTED

- » ventilation undercut
- » plastic ventilation grille
- » aluminum ventilation grille
- » dropping seal

price of door frame includes two hidden concealed hinges.

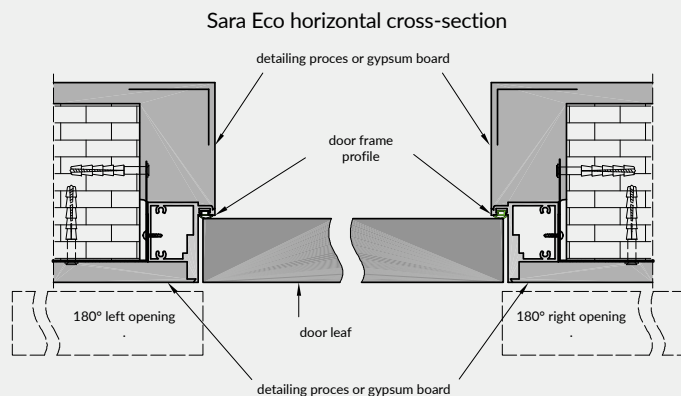

Sara Eco horizontal cross-section (assembly in Gypsum wall)

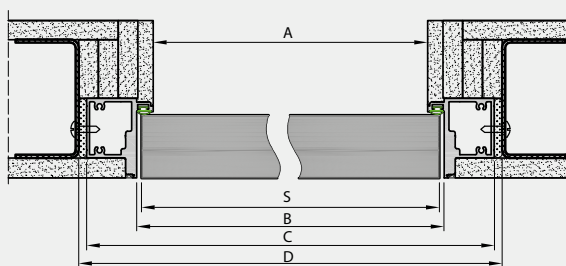

Sara Eco vertical cross-section

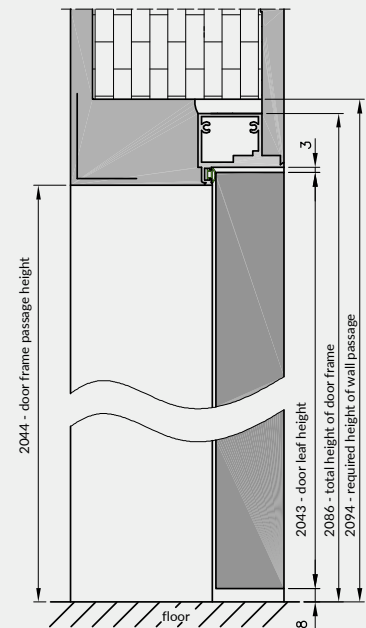

door frame profile with gasket

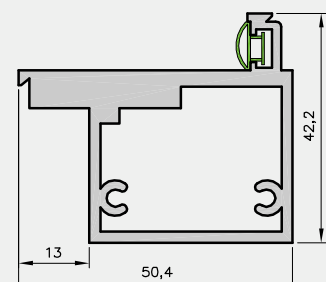

Dimensions of Sara Eco door leaf

	S	A	B	C	D
„70“	744	729	750	814	824
„80“	844	829	850	914	924
„90“	944	929	950	1014	1024

- S - width of door leaf unit
- A - width of passage in door frame unit
- B - width in rebate of door frame
- C - external width of door frame
- D - required width of wall passage

NOTE: Minimum thickness of the wall 75 mm.

Door leaf width: single door leaf „70“÷„90“.

Technical informations: accessories: pp. 129, 156 -163 and 169, door leaf: pp. 170 - 178.

REBATED DOOR LEAF - OPENED INWARDS

Sara Eco door leaf is an innovative solution for creative interior design with the use of "invisible" doors. This unique construction gives possibility to finish surface of door leaf in the colours of the walls.

Construction of SARA ECO door leaf comprises of:

- » Aluminum door frame, "invisible" after assembly process, build in the wall or overlayed with sheets of plaster board. After detailing process, only visible part is rebate of the door frame, prepared for future painting, e.q. in the colours of the walls.
- » Rebated panel construction door leaf is available in two finishing options:
 - » wide surfaces of door leaf are primed and ready for painting or paperhanging (e.q. in the colour of the walls). Edges of the leaf are covered with a paintable edge band. Painting is to be done at one-s discretion or optional choose painted decor.
 - » wide surfaces of door leaf are coated with veneer from DRE - Cell or 3D group, while the edges of the leaf are covered with a edge band in the colour of the veneer.

OPTIONS AVAILABLE WITH EXTRA CHARGE WITH PRIMER

- » ventilation undercut

STANDARD OPTION

- » door leaf frame made of softwood
- » sockets for 2 hidden concealed ISTAR hinges
- » core made of „honeycomb”
- » magnetic lock for simple key, for bathroom lock, for cylinder lock or economic lock

OPTIONS AVAILABLE WITH EXTRA CHARGE IN DRE-CELL, 3D AND PAINTED

- » ventilation undercut
- » plastic ventilation grille
- » aluminum ventilation grille
- » dropping seal

Sara Eco horizontal cross-section

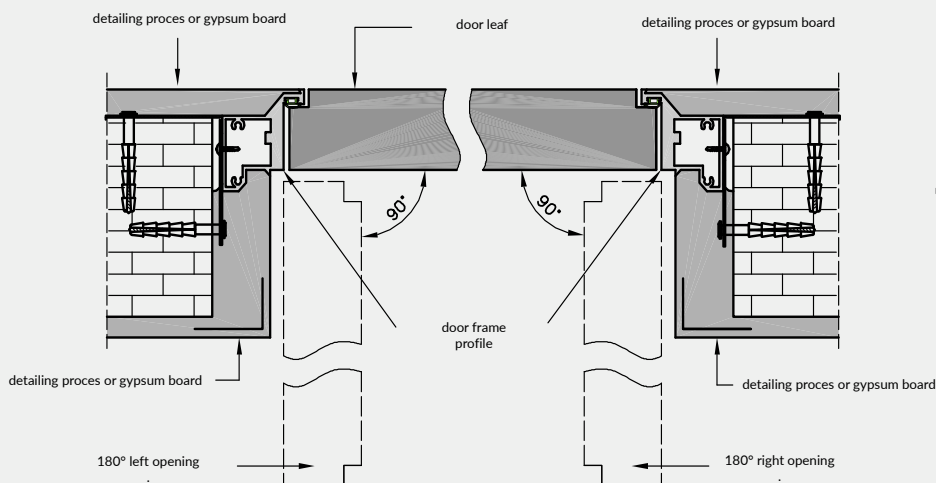

Sara Eco horizontal cross-section (assembly in Gypsum wall)

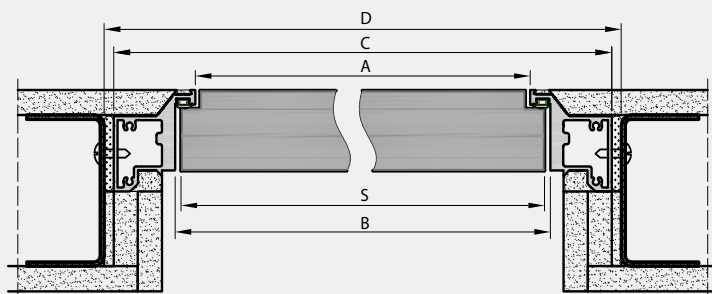

Dimensions of Sara Eco door leaf

	S	A	B	C	D
„70”	744	729	750	814	824
„80”	844	829	850	914	924
„90”	944	929	950	1014	1024

- S - width of door leaf unit
- A - width of passage in door frame unit
- B - width in rebate of door frame
- C - external width of door frame
- D - required width of wall passage

NOTE: Minimum thickness of the wall 75 mm.
Door leaf width: single leaf „70”÷„90”

Sara Eco vertical cross-section

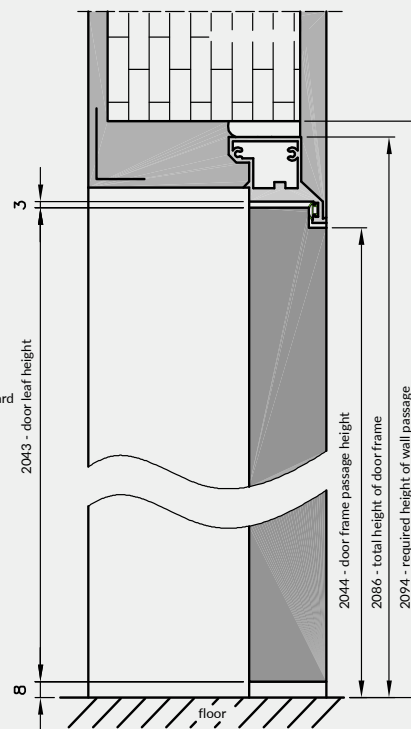

door frame profile with gasket

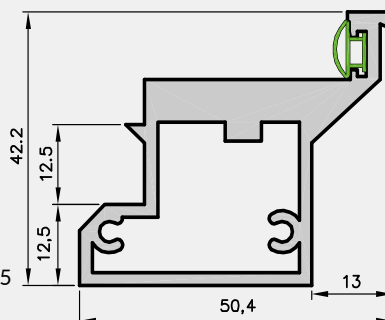



side panel
PREMIUM
(edge
straight)
DRE-Cell
3D foil

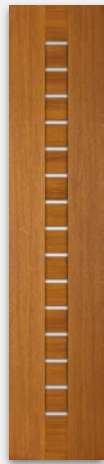

side panel
PIANO
(edge
straight)
DRE-Cell
3D foil

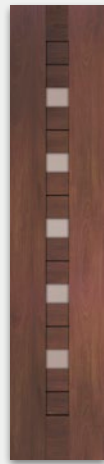

side panel
FOSCA
(edge
straight)
DRE-Cell
3D foil



side panel
SCALA A
(edge
straight)
DRE-Cell
3D foil

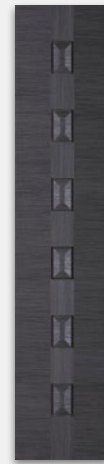

side panel
SCALA B
(edge
straight)
DRE-Cell
3D foil



side panel
ELSA
(edge
straight)
DRE-Cell
3D foil

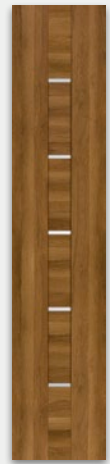

side panel
AURI
(edge
straight)
DRE-Cell
3D foil



Decor
DRE-Cell

*** decor available only in horizontal wood grain

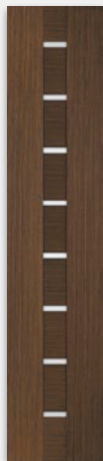

side panel
PREMIUM natura
(straight edge)
Natura



side panel
DOVA natura
(straight edge)
Natura

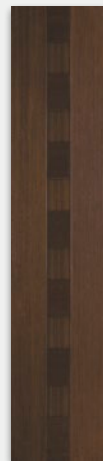

side panel
SCALA natura
(straight edge)
Natura

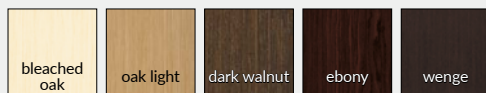

STANDARD OPTION

- » stiles and rails made of MDF
- » glass pane 4 mm: MAT DRE, decormat brown, decormat graphite or transparent glass
- » 3 silver screw-in pivot hinges
- » latch strike plate and two flush bolts
- » straight edge **fig. 1**

OPTIONS AVAILABLE WITH EXTRA CHARGE

- » door frame for door leaf with side panel +30%

NOTE: Price of side panel is equal to the price of corresponding door leaf model.

There is possibility to make side panels to all frame construction door leaf, available in presented collections, in following combinations: „60+40“; „70+40“; „80+40“; „90+40“; „100+40“

NOTE: There is no possibility to shorten side panels.

fig. 1



edge
straight

STANDARD OPTION

- » door leaf frame made of softwood
- » core made of „honeycomb“
- » glass pane 4 mm thick: white bark, "window blind", CHINCHILA, MAT DRE, DECORMAT BROWN or DECORMAT GRAPHITE.
- » 2 silver screw-in pivot hinges
- » latch strike plate and two flush bolts
- » optional: straight edge* flat glazing bar **fig.1** or "karnies" edge, rounded glazing bar **fig. 2**

OPTION WITHOUT ADDITIONAL CHARGE

- » three hinges applies to rebated door leaf

OPTIONS AVAILABLE WITH EXTRA CHARGE

- » core made of perforated chipboard
- » door frame for door leaf with side panel +30%
- » straight edge in CPL laminate with edge band 1,5 mm thick

fig. 1

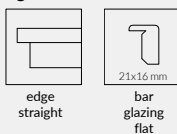
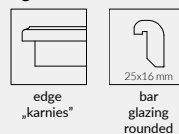

fig. 2



Side panel it is passive rebated door leaf unit with "40" width and 40 mm thick, with glazing or without glazing option, in uniform wood grain. Side panels can be paired with interior rebated door leaf in the following combination: „60+40“; „70+40“; „80+40“; „90+40“; „100+40“.

Side panel 10 can be applied to rebated interior door leaf.

Side panel 30 can be applied to models ARTE 10-30 and STANDARD 30.

Side panels 40 can be applied to models ARTE 40, 50, 90; STANDARD 40, KANON 30, DECO collection.

Side panel 41 can be applied to models MODERN 30, IDEA 30, PLUS 30.

To make the best possible match of side panel to door leaf unit, besides selection of model, it is necessary to choose wright colour, type of the edge and number of hinges.

NOTE: There is no possibility to shorten side panels.



Decor DRE-Cell 1	white (structure)	ash	beech	alder	golden oak	calvados	walnut	<i>* decor is not available in door leaf model with "karnies" edge</i> <i>** available only straight edge</i> <i>*** decor available only in horizontal wood grain</i>												
Decor DRE Cell 2	white mat*	white pine	elm siberian	silver	oak sand	bleached oak textured	vintage oak							walnut caramel	golden oak textured	walnut dark textured	gray oak textured**	elm tabac	elm anthracite	wenge dark
Decor 3D	elm	walnut american	ebony	polish oak 3D	grand oak															
Laminate CPL**	white	white noble VVF7206	light gray	gray dark	acacia	honey oak	chestnut	gray oak	welsh oak	walnut	celini walnut	concrete 1 F6462	roasted walnut							

STANDARD OPTION

- » door leaf frame made of softwood
- » core made of „honeycomb”
- » glass pane 4 mm thick: white bark, "window blind", CHINCHILA, MAT DRE, DECORMAT BROWN or DECORMAT GRAPHITE.
- » 2 silver screw-in pivot hinges
- » latch strike plate and two flush bolts
- » straight edge **fig. 1**

fig. 1

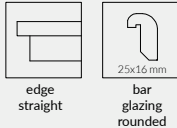

OPTION WITHOUT ADDITIONAL CHARGE

- » three hinges

OPTIONS AVAILABLE WITH EXTRA CHARGE

- » core made of perforated chipboard
- » door frame for door leaf with side panel +30%

Interior rebated single leaf door can be paired together with „40” side panel in combination in the following combination „60+40”; „70+40”; „80+40”; „90+40”; „100+40”. Side panel it is passive rebated door leaf unit 40 mm thick, with glazing or without glazing option, in uniform wood grain.

Side panel Natura 10 can be applied to all collections with natural veneer and with straight edge, besides ENTER natura.

Side panel Natura 02 can be applied to collection Galeria Natura 02, 20, 21, 22, 23, Galeria Natura ALU 20,21,22,23, 24, 25 and Duero Natura ALU.

Side panel Natura 30 can be applied to models ARTE natura 10-30, STANDARD natura 30 with straight edge.

Side panel Natura 40 can be applied to models ARTE natura 40, 50, 70, 90, STANDARD natura 40.

NOTE: There is no possibility to shorten side panels.

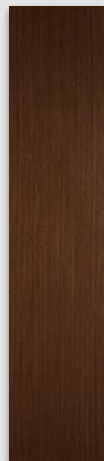

Side panel Natura 10
(horizontal wood grain, straight edge)

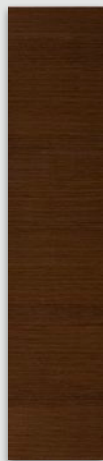

Side panel Natura 02
(horizontal wood grain, straight edge)



Side panel Natura 30
(horizontal wood grain, straight edge)



Side panel Natura 40
(horizontal wood grain, straight edge)

birch	beech	oak	walnut	wenge	veneer natural 1
bleached oak	oak light	walnut bolivian	dark walnut	ebony	

TRANSOM LIGHTS AND SIDELIGHTS

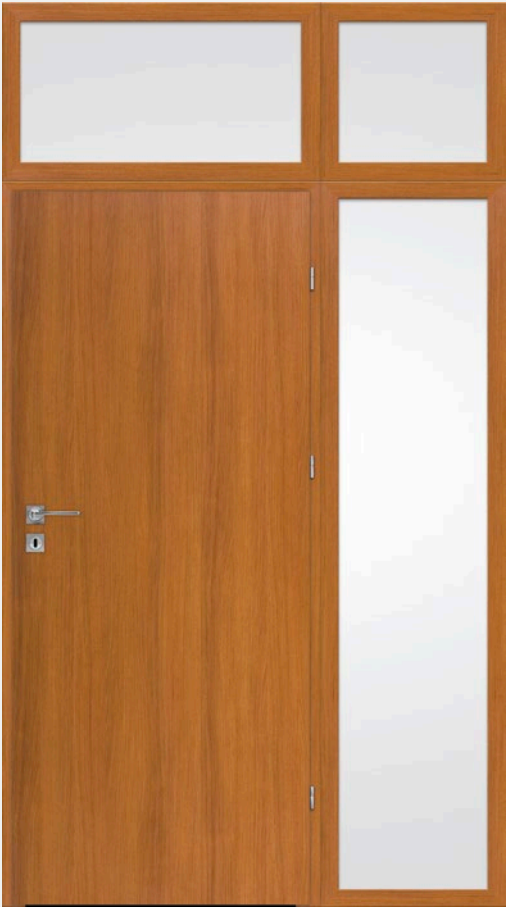

Possible configuration of transom lights/side lights



TRANSOM LIGHTS AND SIDELIGHTS

Transom lights/ sidelights are fixed, unpenable, glazed partition between rooms or spaces that may constitute an independent structure or a supplement for interior doors (except for glass doors) with a fixed door frames. Transom lights/sidelights are manufactured and delivered as a set of components ready for assembly. Set contains the following:

- » two horizontal and two vertical main beams
- » set of cover and instalation strips
- » set of gaskets
- » main beam couplers

Transom lights/sidelights are used in interior doors with a fixed door frames and they come in the following decors DRE-Cell, 3D veneer, Finish veneer and CPL laminate 0,15-0,20 mm.

NOTE: Our product doesn't come with the glass pane, which should be purchased by the Client separately. We reccomend to use tempered glass pane with a thickness of 4 mm. Assembly of transom lights/sidelights should be performed once the "wet" construction are completed.

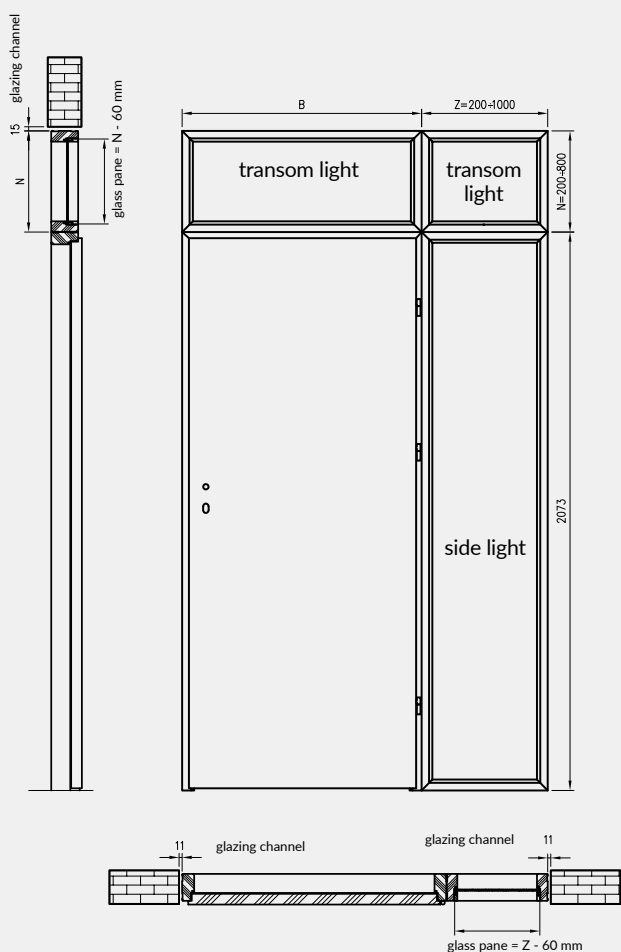
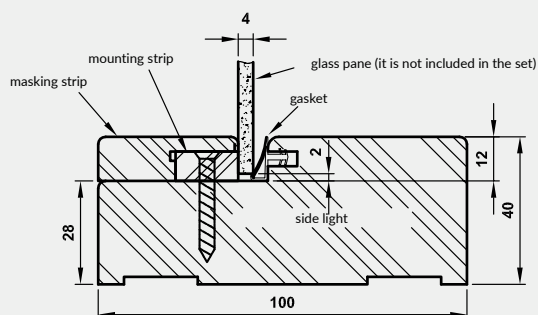

Fig. A cross-section of the transom light/sidelights



Dimensions of transom lights/sidelights

range of products	height total	width total	length of the perimeter
side light	2073 mm	Z	$2 \cdot 2073 + 2 \cdot Z$
sidelight	N	Z	$2 \cdot N + 2 \cdot Z$
transom light	N	B	$2 \cdot N + 2 \cdot B$

available options of transom lights heights

„N” = 200-800 mm.

available options of the width of transom and side lights

„Z” = 200-1000 mm.

Width of the upper "B" transom lights is adjusted to the width of the fixed door frames; the available options of the width of fixed door frames; available options of the widths can be found in the following tables:

The transom lights are mounted on the single-leaf door frame

	„60”	„70”	„80”	„90”	„100”	„110”
B	688	788	888	988	1088	1188

Transoms mounted with the door frame in double-leaf doors

	„100d”	„110d”	„120”	„130”	„140”	„150”	„160”	„170”	„180”	„190”	„200”
B	1123	1223	1323	1423	1523	1623	1723	1823	1923	2023	2123

Price of the transom lights/sidelights is calculated per one meter of circumference measured on the outer side of the transom lights/sidelights.

To place an order please contact Atypical Orders Department - phn. 55 236 42 59.

NOTE: height of the sidelight is adapted to the standard height of the fixed door frame. Therefore, we do not reccomend shortening door frames in configuration with the sidelight.

ENTER NATURA

REBATED
interior entrance door leaf



STANDARD OPTION

- » door leaf frame made of MDF additionally reinforced with two flat metal bars
- » core made of perforated chipboard
- » external flat HDF board
- » 3 silver screw-in pivot hinges
- » straight edge **fig. 1**
- » bottom deadbolt lock adapted for door lock cylinder
- » upper deadbolt lock adapted for door lock cylinder

fig. 1



edge
straight

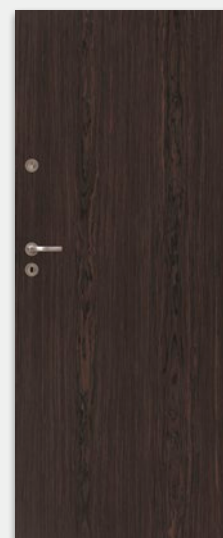

ENTER natura 0

APPLICATION

Door leaf ENTER natura can be used as internal entrance door in multifamily buildings and public utility buildings.

NOTE: The specificity of natural veneer is a possibility of differences in wood grain and staining. These differences can not be the basis of the accepted complaint.

OPTIONS AVAILABLE WITH EXTRA CHARGE

- » viewfinder - included separately
- » digital viewfinder DDS1 - included separately
- » digital viewfinder DDS2 - included separately
- » stainless steel threshold - 70 mm wide
- » cancellation of second lock
- » dropping seal



veneer
natural 1

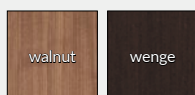

veneer
natural 2



veneer
natural 3



viewfinder
included
separately



steel
threshold
(70 mm
wide)



deadbolt lock
upper

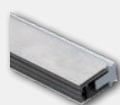

seal
dropping



digital viewfinder DDS1
(separately)



digital viewfinder DDS2 (separately)

CONSTRUCTION

Construction door leaf frame is made of MDF board (A) additionally reinforced with two flat metal bars (B). Core is made of perforated chipboard (C).

Door leaf unit has increased acoustic insulation (Rw=32dB). External HDF board is ennobled with natural veneer secured with UV varnish.

It is recommended to use together with door leaf collection ENTER natura fixed door frame Soft natura.

cross-section of ENTER natura

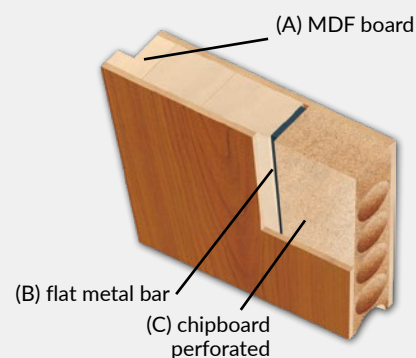

ACCESSORIES

PATENTED CYLINDERS



patented cylinder 26/41
- nickel mat



patented cylinder 26/41
- brass satin



set of patented cylinder ZN
30/40+30G/40 SN
or ZN 30/40+40G/30 SN nickel satin

system
single key system



set of patented cylinder ZN
30/40+30G/40 SB
or ZN 30/40+40G/30 SB brass satin

DIGITAL VIEWFINDER AXA DDS1



DIGITAL VIEWFINDER AXA DDS2



SELF-CLOSER



self-closer DORMA



self-closer GEZE



PRESTIGE door handle
and backplate
for FORCA 10 - pp. 132



ONTARIO door handle
and backplate
for SOLID RC2 model

Price for a set of entrance doors ENTER 0 with door frame made of MDF



STANDARD OPTION

- » door leaf frame made of MDF additionally reinforced with two flat metal bars
- » core made of perforated chipboard
- » external HDF board - flat or with decorative milling .
- » 3 silver screw-in pivot hinges
- » straight edge **ig. 1** or edge R 2,5 mm (in CPL laminate) **ig. 2**

REBATED DOOR LEAF MODEL ENTER:

- » bottom deadbolt lock adapted for door lock cylinder
- » upper deadbolt lock adapted for door lock cylinder

REBATED DOOR LEAF SOLID

- » multipoint mortise lock adapted for door lock cylinder CLASS "C"
- » hinges reinforced with anti-thrust bolts

APPLICATION

Door leaf ENTER and SOLID can be used as internal entrance door in multifamily and in public utility buildings.

CONSTRUCTION

Construction door leaf frame is made of MDF, additionally reinforced with two flat metal bars. Core is made of perforated chipboard. Door leaf unit has increased acoustic insulation (Rw=32dB). External HDF board is ennobled with DRE-Cell veneer - optional - flat finishing or decorative milling.

Door leaf models ENTER/SOLID are available with 0,7 - 0,8 mm CPL laminate - to place an order and for more information please contact Customer Service Department.

NOTE: Models ENTER 0 and SOLID 0 - door leaf in CPL laminate has in standard option edge with radius R 2,5 mm. There is possibility to choose straight edge (extra charge) with edge band 1,5 mm thick.

It is recommended to use together with door leaf collection ENTER/SOLID fixed door frame ENTER/SOLID or metal door frame.

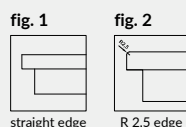

* door handle and upper backplate METRO, set of patented cylinder - single key system

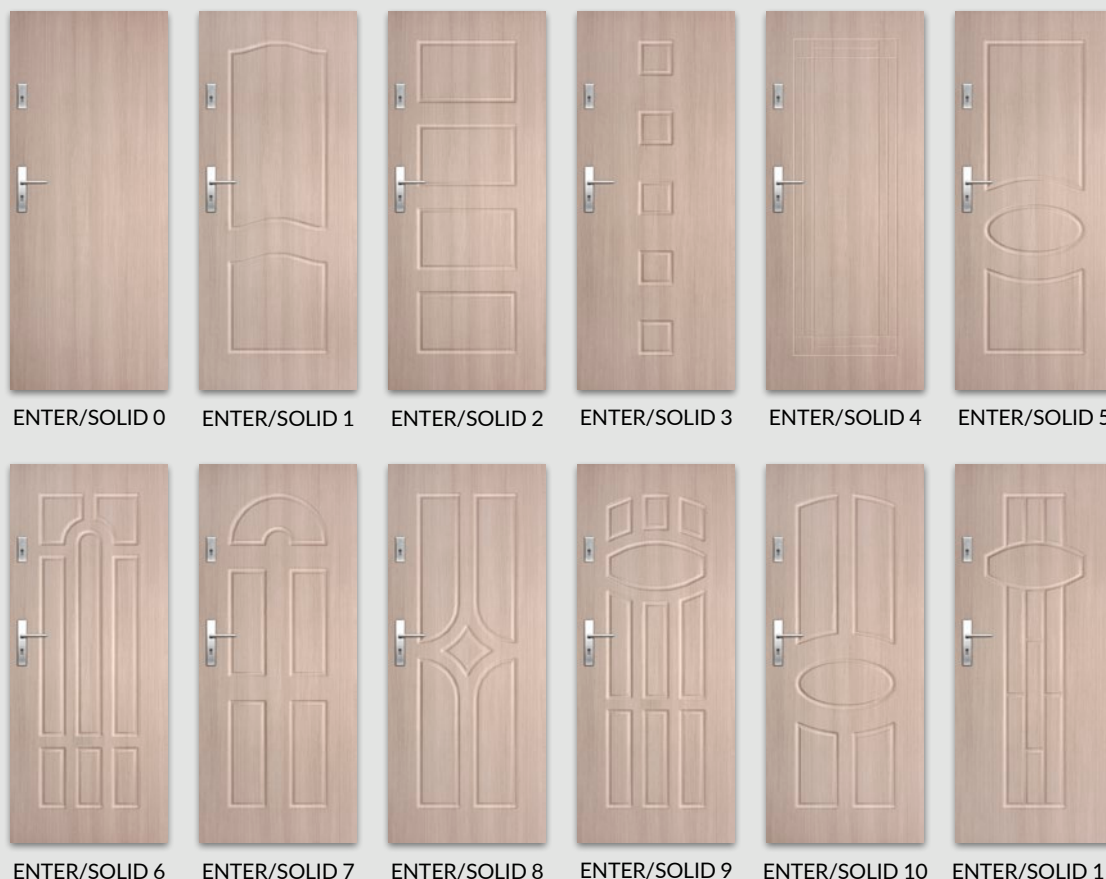

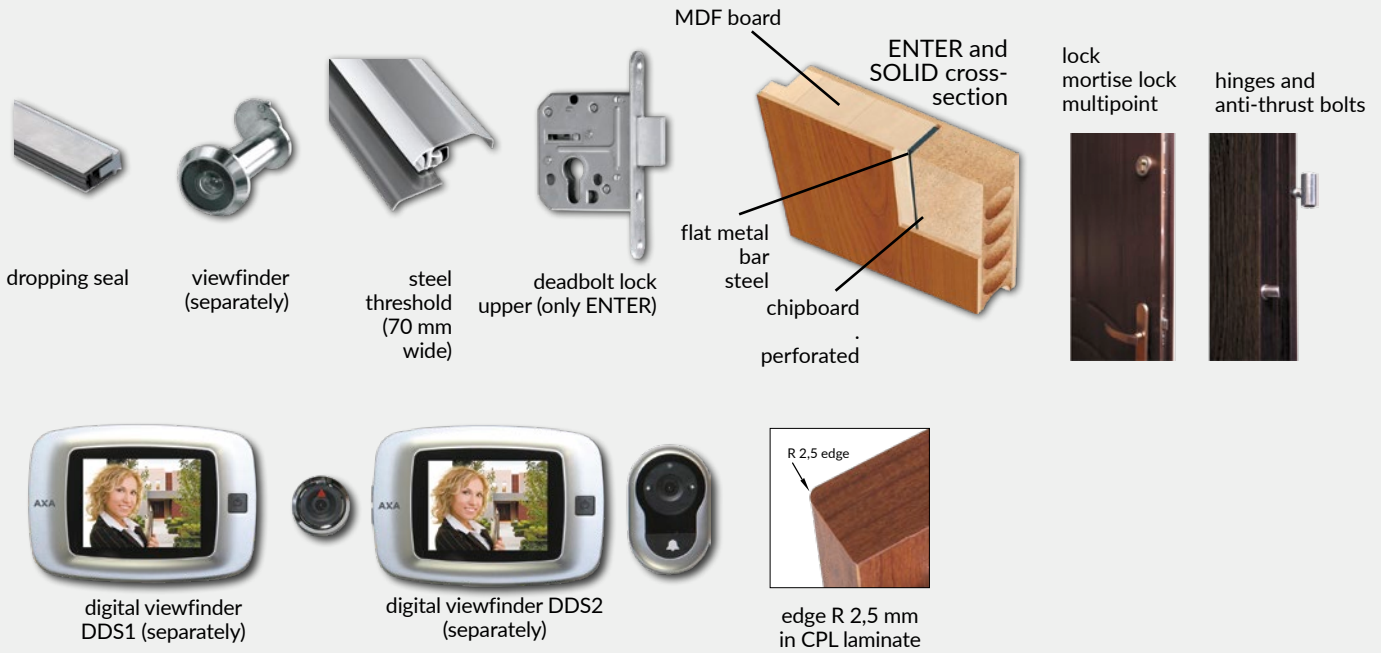

OPTIONS AVAILABLE WITH EXTRA CHARGE

- » In CPL laminates straight edge with edge band 1,5 mm thick
- » viewfinder - included separately
- » digital viewfinder DDS1 - included separately
- » digital viewfinder DDS2 - included separately
- » stainless steel threshold - 70 mm wide
- » cancellation of second lock
- » dropping seal

Decor DRE-Cell 1	white (structure)	ash	beech	alder	golden oak	calvados	walnut						Decor DRE-Cell 2	white mat	silver
Decor DRE-Cell 3	white pine	elm siberian	oak sand	bleached oak textured	vintage oak	walnut caramel	golden oak textured	dark walnut textured	gray oak textured***	elm tabac	elm anthracite	wenge dark			
Decor 3D	grand oak	elm	walnut american	ebony	polish oak 3D										
Laminate CPL	white	white noble VVF7206	light gray	gray dark	concrete 1 F6462	gray oak	welsh oak	acacia	celini walnut	walnut	honey oak	chestnut	roasted walnut		

*** decor available only in horizontal wood grain

Price for a set of entrance doors ENTER 0 with metal door frame



*** door handle and upper backplate, set of patented cylinder - single key system.

STANDARD OPTION

- » door leaf frame made of MDF additionally reinforced with two flat metal bars
- » core made of perforated chipboard
- » external HDF board - flat or with decorative milling .
- » 3 silver screw-in pivot hinges
- » straight edge fig.1 or edge R 2,5 mm (in CPL laminate) fig. 2

REBATED DOOR LEAF MODEL ENTER:

- » bottom deadbolt lock adapted for door lock cylinder
- » upper deadbolt lock adapted for door lock cylinder

REBATED DOOR LEAF SOLID

- » multipoint mortise lock adapted for door lock cylinder CLASS "C"
- » hinges reinforced with anti-thrust bolts

APPLICATION

Door leaf ENTER and SOLID can be used as internal entrance door in multifamily and in public utility buildings.

It is recommended to use together with door leaf collection ENTER/SOLID fixed door frame ENTER/SOLID or fixed metal door frame.

CONSTRUCTION

Construction door leaf frame is made of MDF, additionally reinforced with two flat metal bars. Core is made of perforated chipboard. Door leaf unit has increased acoustic insulation (Rw=32dB). External HDF board is ennobled with DRE-Cell veneer - optional - flat finishing or decorative milling.

fig. 1



straight edge

fig. 2



R 2,5 edge



ENTER/SOLID 12 ENTER/SOLID 13 ENTER/SOLID 14 ENTER/SOLID 15 ENTER/SOLID 16 ENTER/SOLID 17



ENTER/SOLID 18 ENTER/SOLID 19* ENTER/SOLID 20* ENTER/SOLID 21** ENTER/SOLID 22** ENTER/SOLID 23**

* in models 19 and 20 veneer is glued in strips with variable wood grain.

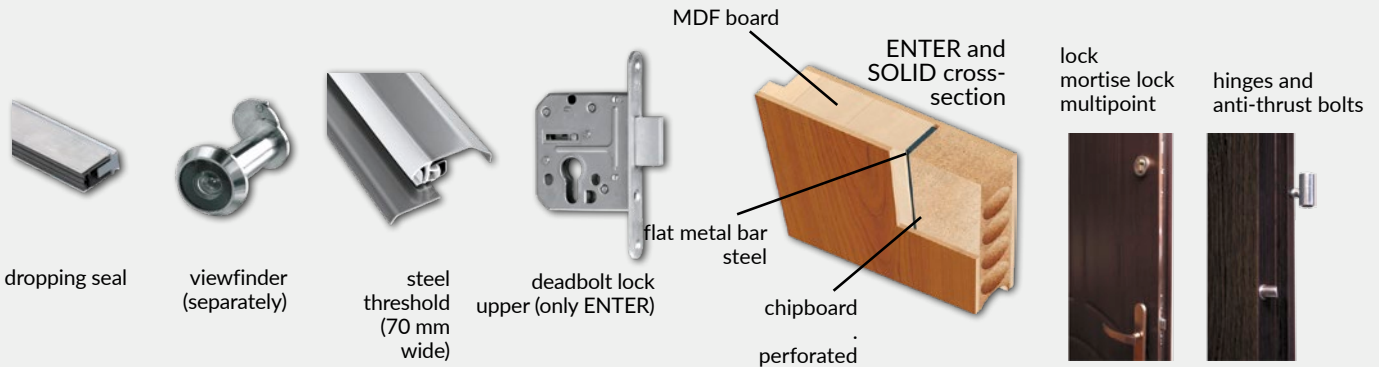

NOTE: ENTER 21-23 models and SOLID 21-23 models - door leaf in CPL laminate standard edge with radius R 2,5 mm. There is possibility to choose straight edge with edge band 1,5 mm thick.

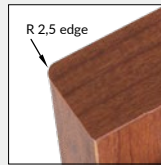
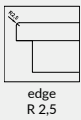

edge R 2,5 mm in CPL laminate



** in models 21-23 there are aluminum marrquetry elements installed in one surface of door leaf



Decor DRE-Cell 1	white (structure)	ash	beech	alder	golden oak	calvados	walnut						Decor DRE-Cell 2	white mat	silver
	white pine	elm siberian	oak sand	bleached oak textured	vintage oak	walnut caramel	golden oak textured	dark walnut textured	gray oak textured***	elm tabac	elm anthracite	wenge dark			
Decor 3D	grand oak	elm	walnut american	ebony	polish oak 3D										
Laminate CPL	white	white noble VVF7206	light gray	gray dark	concrete 1 F6462	gray oak	welsh oak	acacia	celini walnut	walnut	honey oak	chestnut	roasted walnut		



SOLID RC2 - chestnut CPL

Laminate CPL													
Available colours of fixed steel door frame													

Price for a set* entrance doors SOLID RC2

* door leaf SOLID RC2, fixed steel door frame and steel threshold

STANDARD OPTION:

- » door leaf frame made of soft wood
- » core made of chipboard
- » straight edge with edge band 1,5 mm thick
- » multipoint mortise lock
- » 3 threefold hinges
- » external HDF board with aluminum foil

SOLID RC2 door leaf has acoustic insulation class $R_w=32\text{dB}$ and has anti-burglary class RC2 according to PN-EN 1627:2012. To comply with technical approval whole set must comprise of door leaf, fixed steel door frame, steel threshold and purchased separately dedicated for this product hardware: door handle, backplate and cylinder patent inserts. Picture of door handle and backplate can be found on page 129.

APPLICATION

Door leaf SOLID RC2 can be used as internal entrance door in multifamily buildings and in public utility buildings.

OPTIONS AVAILABLE WITH EXTRA CHARGE

- » viewfinder
- » door leaf „100”
- » steel threshold
- » ONTARIO door handle
- » ONTARIO backplate
- » cylinder patent insert DRAGON (price for 2 pcs.)

CONSTRUCTION OF DOOR FRAME

Metal welded door frame is made of low carbon steel sheet with 1,5 mm thickness. Door frame is powder coated and available in colours from RAL pallet: 9003-white, 8017-brown, 7047-light gray, 7024-dark gray in two gloss scale (mat low structure/semi gloss). Both external side and internal side of door frame are secured with lacquered organic protective surface.

On its one side there are made 4 holes for latch bolt and bolts installed in entrance DRE doors, and on the opposite side there are 3sockets for hinges and anti-thrust bolts.

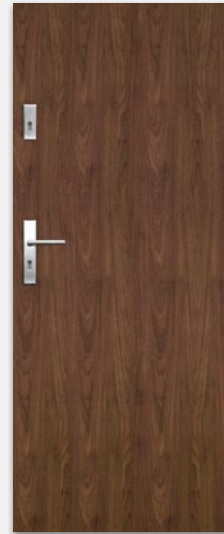

SOLID RC2

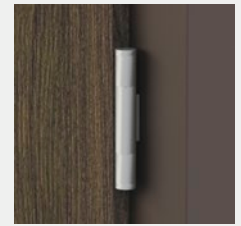

threefold hinge E878

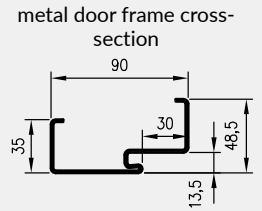

metal door frame cross-section

APPLICATION

Metal door frame can be applied to interior entrance door leaf SOLID RC2. Door frame is designed to be assembled on finished floor level.

STANDARD OPTION

- sockets for 3 threefold hinges E878
- additional sockets for anti-thrust bolts
- sockets for multi point lock latch Metalplast

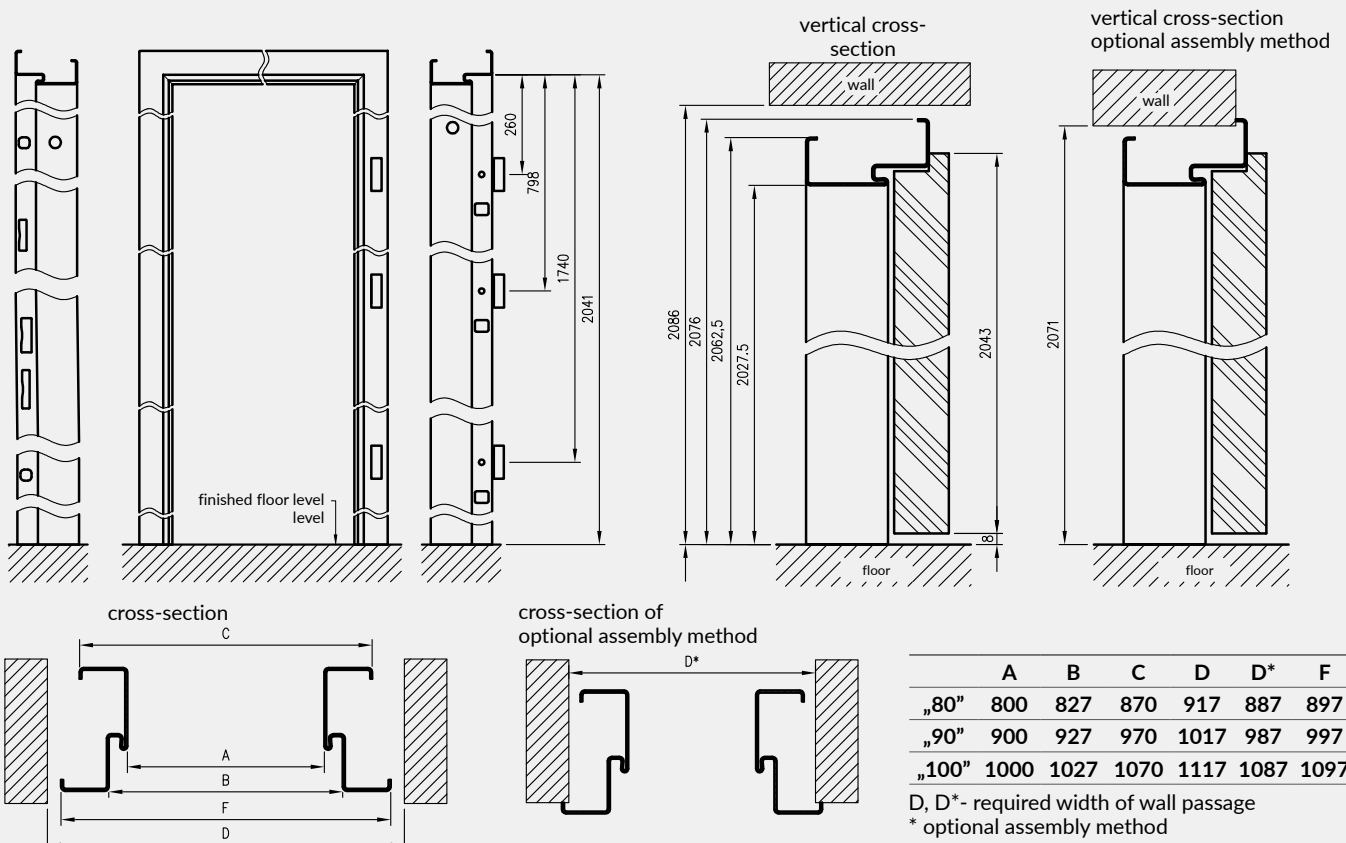

** required height of wall passage measured from the level of finished floor is 2086 mm or 2071* mm in optional assembly method
** height of passage in the door frame is 2027,5 mm



*** decor available only in horizontal wood grain

FORCA TECHNICAL DOORS MEET THE FOLLOWING REQUIREMENTS:

- » anti-burglary class RC3 (according to PN-EN 1627:2012) class C (in accordance with PN-B-92270:1999)
- » fire resistance class: EI₁₃₀
- » smoke tightness: Sa, Sm
- » mechanical resistance class: 4
- » sound insulation class: RW=37 dB

APPLICATION

Interior entrance fire-resistance and anti-burglary doors, are used in residential housing, public utility buildings and collective residential buildings, as well as commercial and technical premises. Doors are sold only as a complete set with a wooden door frame, wooden threshold, backplate, and two cylinder inserts.

STANDARD OPTION

- » door leaf frame made of soft wood
- » core made of chipboard
- » straight edge
- » steel strings
- » 5-point mortise lock
- » 3 screw-in pivot hinges

OPTIONS AVAILABLE WITH EXTRA CHARGE

- » selfcloser DORMA
- » selfcloser GEZE
- » door leaf "100"

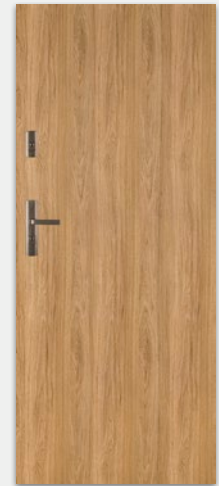

FORCA 10

In order to comply with TECHNICAL APPROVAL doors with fire resistance of EI30 and anti-burglary properties, should be equipped with a self closer and PRESTIGE door handle with backplate. Picture of handle and backplate is available on page 129.

wooden door frame- front view

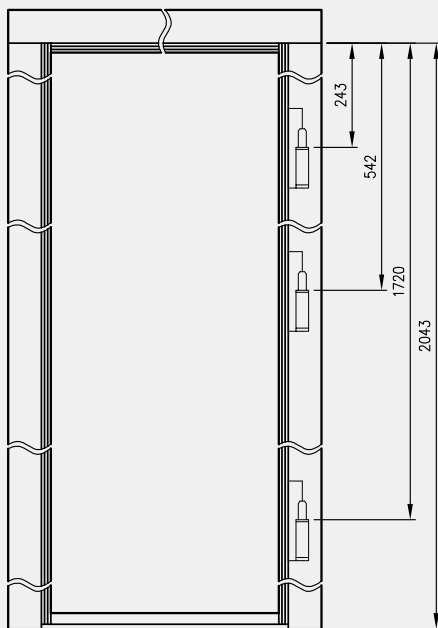

vertical cross-section FORCA doors

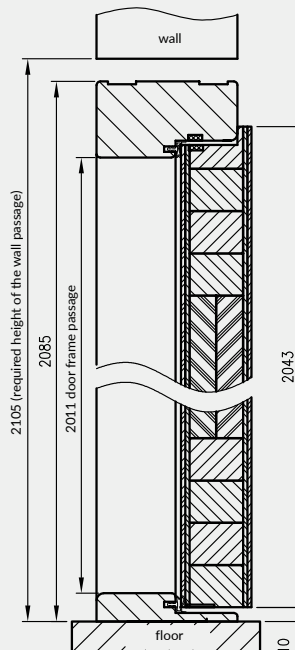

cross-section of a wooden door frame of a lintel for FORCA door leaf

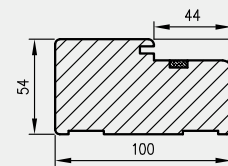

horizontal cross-section of door frame mounted in the wall

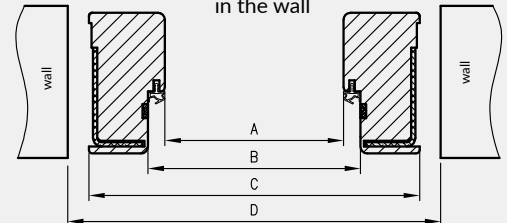

	A	B	C	D
„80”	800	824	908	948
„90”	900	924	1008	1048
„100”	1000	1024	1108	1148

D - required width of wall passage

Interior entrance fire-resistance doors



*** decor available only in horizontal wood grain

ATHOS TECHNICAL DOORS MEET THE FOLLOWING REQUIREMENTS:

- » fire resistance class: EI 30
- » smoke tightness: Sa, Sm
- » mechanical resistance class: 4
- » sound insulation class: RW=32 dB

APPLICATION

Interior entrance fire-resistance doors, are used in residential housing, public utility buildings and collective residential buildings, as well as commercial and technical premises.

Doors are sold only as a complete set with a wooden door frame and wooden threshold.

STANDARD OPTION

- » door leaf frame made of soft wood
- » core made of chipboard
- » straight edge
- » single-point mortise lock adapted for cylinder lock
- » 3 screw-in pivot hinges

OPTIONS AVAILABLE WITH EXTRA CHARGE

- » selfcloser DORMA
- » selfcloser GEZE
- » door leaf "100"

In order to comply with the conditions of TECHNICAL APPROVAL, doors with fire resistance of EI30 should be equipped with a self closer.



ATHOS 10

wooden door frame- front view

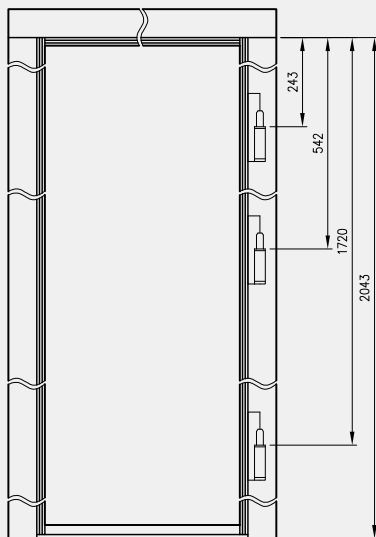

vertical cross-section ATHOS doors

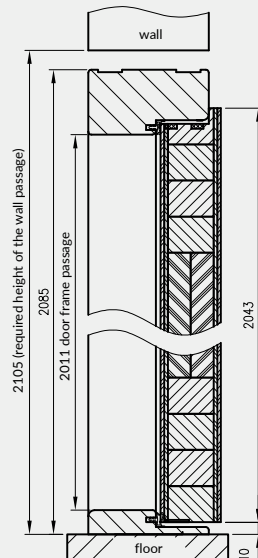

cross-section of a wooden fire-resistance door frame for FORCA leaf.

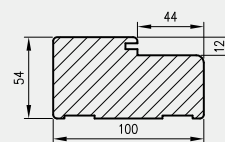

horizontal cross-section of door frame mounted in the wall

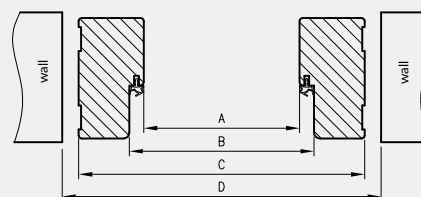

	A	B	C	D
„80“	800	824	908	948
„90“	900	924	1008	1048
„100“	1000	1024	1108	1148

D - required width of wall passage

OPTIONS AVAILABLE WITH EXTRA CHARGE

» ventilation undercut available in swing door leaf
(door leaf „80“ and „90“ meet ventilation requirements)



GALLA 1
transparent



GALLA 1
decormat



GALLA 1
decormat brown



GALLA 1
decormat graphite



GALLA 2
sand blasted glass
transparent strips



GALLA 3
sand blasted glass
transparent strips



GALLA 10
decormat
screen printing



GALLA 10
transparent glass
screen printing



GALLA 11
decormat
screen printing

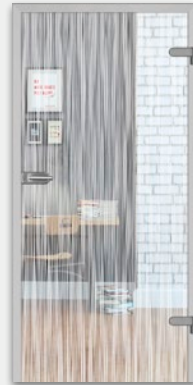

GALLA 11
transparent glass
screen printing



GALLA 12
decormat
screen printing



GALLA 13
decormat
screen printing

Door leaf is made of tempered, 8mm glass pane.

OPTIONS AVAILABLE WITH EXTRA CHARGE

» ventilation undercut available in swing door leaf
 (door leaf „80” and „90” meet ventilation requirements)



GRACCA 1



GRACCA 2



GRACCA 3



GRACCA 3
transparent

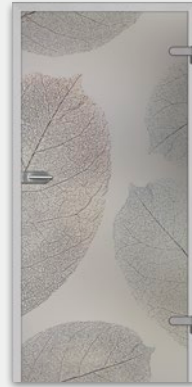

GRACCA 4



GRACCA 5



GRACCA 6



GRACCA 6
transparent

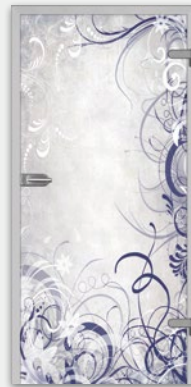

GRACCA 7



GRACCA 8



GRACCA 9



GRACCA 10

Door leaf is made of tempered, 8mm glass pane with ceramic, permanent digital printing presented on particular model.



OPTIONS AVAILABLE WITH EXTRA CHARGE

» ventilation undercut available in swing door leaf
(door leaf „80” and „90” meet ventilation requirements)



GRACCA 11



GRACCA 12



GRACCA 13



GRACCA 14
transparent



GRACCA 15



GRACCA 16



GRACCA 17



GRACCA 18



GRACCA 19



GRACCA 20



GRACCA 21



GRACCA 22

Door leaf is made of tempered, 8mm glass pane with ceramic, permanent digital printing presented on particular model.

OPTIONS AVAILABLE WITH EXTRA CHARGE

» ventilation undercut available in swing door leaf
(door leaf „80” and „90” meet ventilation requirements)



GOSSA 1

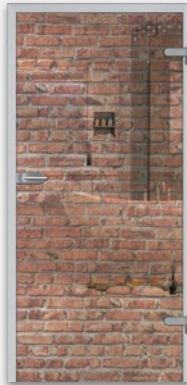

GOSSA 1
transparent

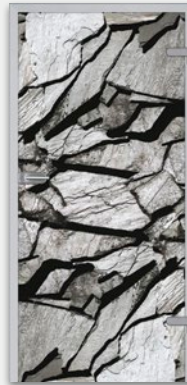

GOSSA 2

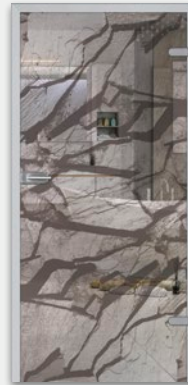

GOSSA 2
transparent



GOSSA 3

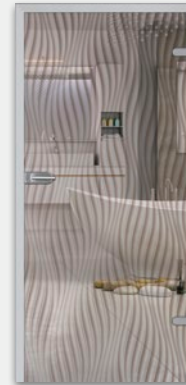

GOSSA 3
transparent



GOSSA 4



GOSSA 4
transparent

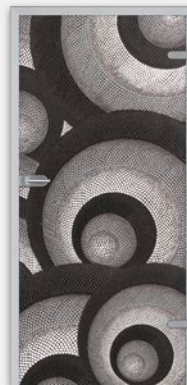

GOSSA 5



GOSSA 5
transparent



GOSSA 6



GOSSA 6
transparent



GOSSA 7

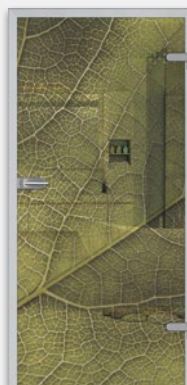

GOSSA 7
transparent



GOSSA 8



GOSSA 9
transparent



GOSSA 10



GOSSA 11

Door leaf is made of laminated glass which consist of two tempered 4 mm glass panes glued together by foil with high quality printing.

OPTIONS AVAILABLE WITH EXTRA CHARGE

» ventilation undercut available in swing door leaf
(door leaf „80” and „90” meet ventilation requirements)



GOSSA 12



GOSSA 13



GOSSA 14



GOSSA 15

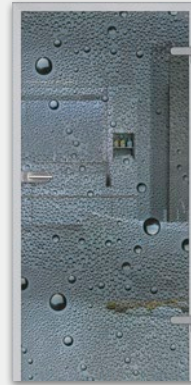

GOSSA 16
transparent

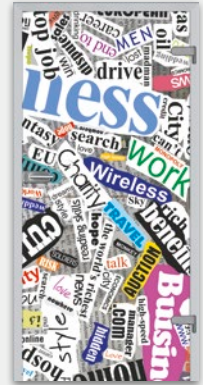

GOSSA 17



GOSSA 18



GOSSA 19



GOSSA 20

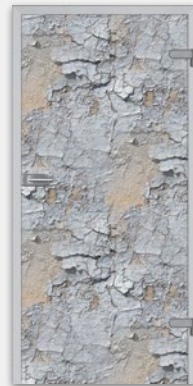

GOSSA 21



GOSSA 22

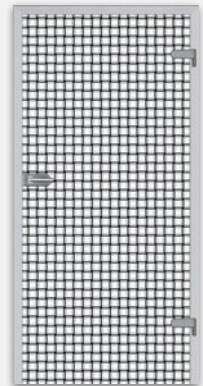

GOSSA 23



GOSSA 24



GOSSA 25



GOSSA 26



GOSSA 27

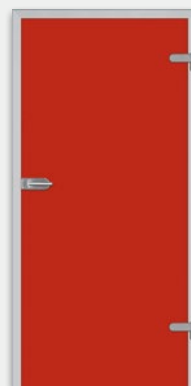

GOSSA 28



GOSSA 29

Door leaf is made of laminated glass which consist of two tempered 4 mm glass panes glued together by foil with high quality printing.

Models GOSSA 26-29 - door leaf is made of laminated glass which consist of two tempered 4mm, painted glass panes glued together by foil.

TECHNICAL INFORMATIONS

APPLIES TO GLASS DOORS GALLA, GOSSA, GRACCA

DOOR LEAF DIMENSIONS AND PLACEMENT OF HARDWARE

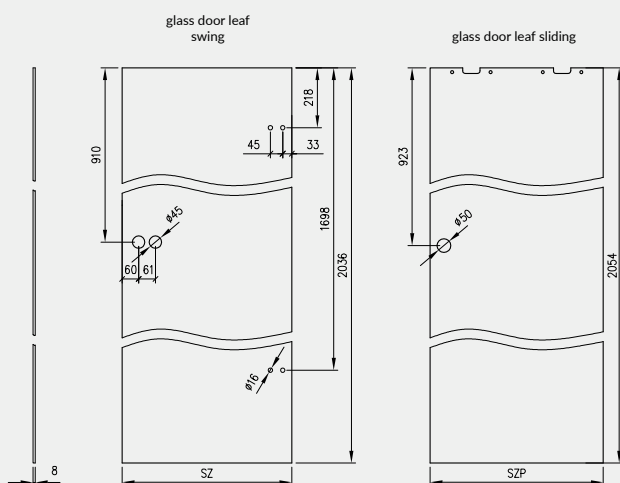

Door leaf unit is made of safe, plain or glued, tempered 8mm glass pane which has in standard option holes for assembly of:

- » hinges and lock in swing doors leaf
- » round door handle and hardware adapted for sliding system door leaf

APPLICATION

Glass door leaf are used as interior doors in residential housing, public utility buildings and collective residential buildings.

OPENING DIRECTION OF GLASS DOOR LEAF

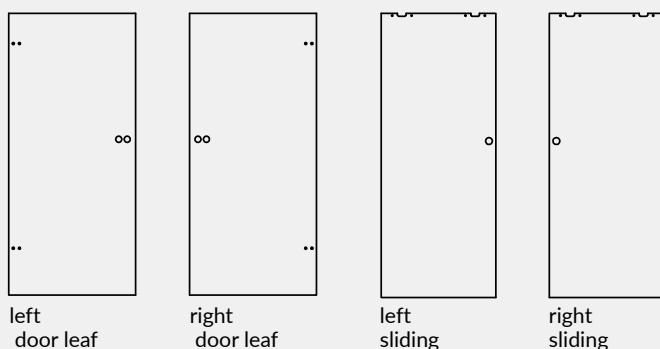

GALLA and GRACCA collections have obverse and reverse side. GOSSA collection has uniform pattern on both sides, visible surfaces of door leaf are plain.

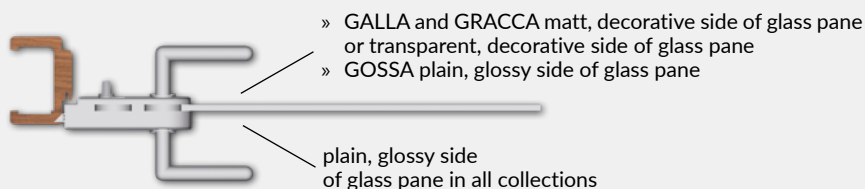

DOOR LEAF WIDTH

Symbol of the door dimension	SZ	SZP
„60”	617	630
„70”	717	730
„80”	817	830
„90”	917	930

SZ - width of glass swing door leaf

SZP - width of glass sliding door leaf

DOOR LEAF HEIGHT

2036 mm - height of glass swing door leaf

2054 mm - height of glass sliding door leaf

NOTE: . There is no possibility to shorten glass door leaf.

CLEARANCE BETWEEN DOOR LEAF AND FLOOR

Standard clearance between door leaf unit and ready floor is 8 mm.

NOTES REFERRED TO HINGES

DOOR FRAMES applied to glass doors should be equipped with two pivot $\varnothing 15$ mm.

FULFILMENT OF VENTILATION REQUIREMENTS FOR GLASS DOORS

symbol dim. DOORS	doors with ventilation undercut	
	ventilation surface of the undercut and the clearance 8 mm [m ²]	required clearance to meet ventilation requirements [in mm]
„90”	0,027	2
„80”	0,024	5,5
„70”	0,021	10*
„60”	0,017	16*

* - door leaf „60” and „70” doesn't meet ventilation requirements.

Ventilation undercut (only swing door leaf)

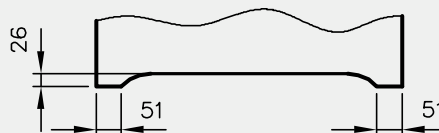

Use of ventilation undercut in door leaf unit with width „80” - „90” and standard clearance between door leaf and floor (8mm) will fulfill ventilation requirement - total ventilation surface 0,022 m².

HARDWARE FOR GLASS DOORS

DOOR LEAF

SELECTION OF LOCKS FOR GLASS DOORS

Depending on door leaf opening direction (left/right):

GEZE toilet locks and all Metalbud locks are configured, to left doors - left locks are used, to right doors - right locks are used remaining door locks are universal use (they can be configured left or right).

In toilet lock it is necessary to choose one of the following combinations which present assembly situation (difference is in door leaf opening direction and/or placement of toilet blockade):

fig. 1 right door leaf /blockade outside

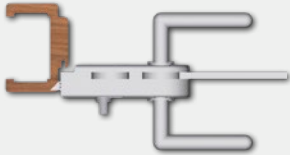

Geze and Metalbud toilet locks - select right toilet lock outside.
remaining locks - select left lock*

fig. 2 left door leaf/blockade outside

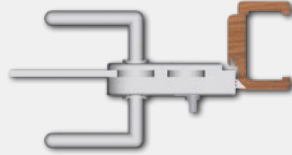

Geze and Metalbud toilet locks - select left toilet lock outside.
remaining locks - select left lock*

fig. 3 right door leaf/blockade inside

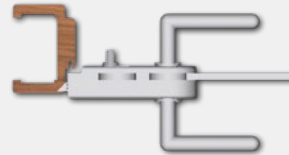

Geze and Metalbud toilet locks - select right toilet lock inside.
remaining locks - select right lock*

fig. 4 left door leaf/blockade inside

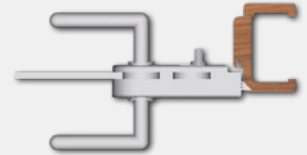

Geze and Metalbud toilet locks - select left toilet lock inside.
remaining locks - select right lock*

* In toilet locks, except Geze and metalbud locks, definition "left", "right" refers to placement of toilet blockade: description "left lock" means that blockade is placed on exterior side of the door leaf, description "right lock" means that blockade is placed on interior side of the door leaf.

HARDWARE



aluminum lock



aluminum lock toilet***



aluminum lock simple key lock



aluminum lock cylinder lock**



hinge aluminum



GEZE lock



GEZE lock toilet***



GEZE lock simple key lock



GEZE lock cylinder lock**



GEZE hinge



steel lock



steel lock toilet***



steel lock simple key lock



steel lock cylinder lock**



steel hinge



steel lock Metal-Bud rectangular



steel toilet lock*** Metal-Bud rectangular



simple key steel lock Metal-Bud rectangular



steel cylinder lock** Metal-Bud rectangular



steel hinge Metal-Bud rectangular



steel lock Metal-Bud rounded



steel toilet lock*** Metal-Bud rounded



simple key steel lock Metal-Bud rounded



steel cylinder lock** Metal-Bud rounded



steel hinge Metal-Bud rounded

** It is necessary to purchase patented cylinder 21/26 separately (see details in the table above)

*** Toilet lock - selection of toilet lock see details above

FIXED DOOR FRAMES

CONSTRUCTION

Fixed door frame is made of high-quality MDF board and it is coated with ecological, wood-like decorative DRE-Cell veneer, 3D veneer, 0,15 - 0,20 mm CPL, finish veneer or natural veneer.

Door frames has fixed width of 100 mm.

APPLICATION

Fixed door frame can be used in the following types of doors:

- » ENTER entrance doors (equipped with 3 \varnothing 13,5 mm hinges and additional upper latch plate)
- » SOLID entrance doors (equipped with 3 \varnothing 13,5 mm hinges and 4 hooks for the latch and latches of the flat multi-point lock)
- » glass doors ("OPC" they are equipped with two hinges \varnothing 15 mm, special latch plate and rubber seal strip)
- » other remaining rebated door leaf (using 2 or 3 \varnothing 13,5 mm hinges, in all frame construction door and panel door collections having size "90" and wider; door frames should be equipped with 3 hinges)

Masking strips are used in fixed door frames and SOFT door frames, whereas for the fixed SOFT natura door frames angular architrave are used.

THE SET CONTAINS

Main beam (one horizontal and two vertical elements), door seal, a set of hinges, all necessary components for the installation of door frames in accordance with the supplied instruction. Door frames are packed in cardboard boxes.

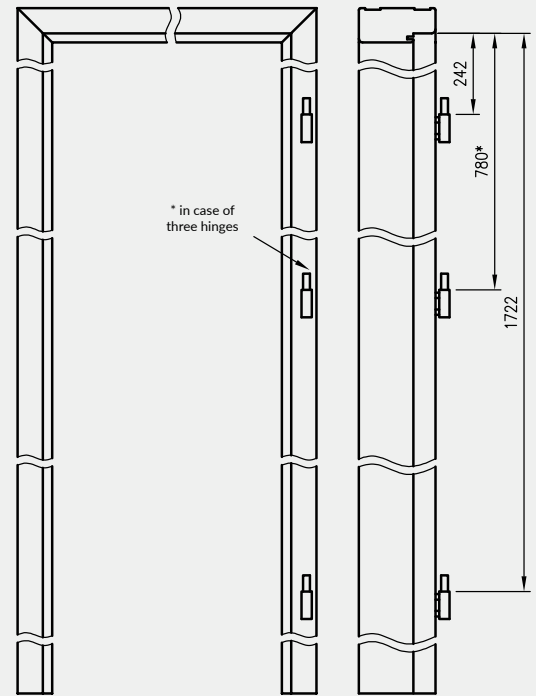
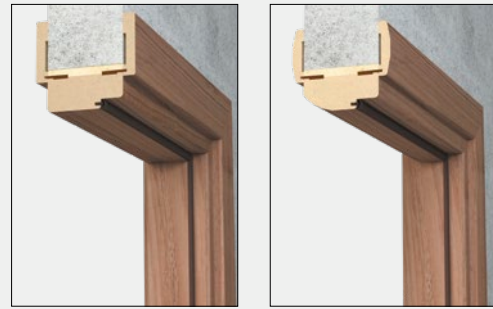

Fixed door frame

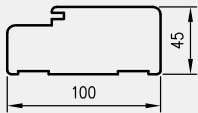

vertical cross-section of rebated door leaf

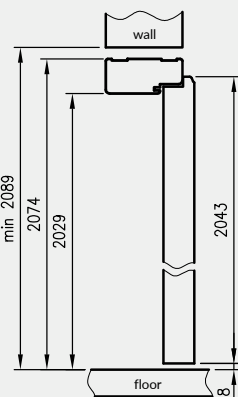

vertical cross-section glass doors

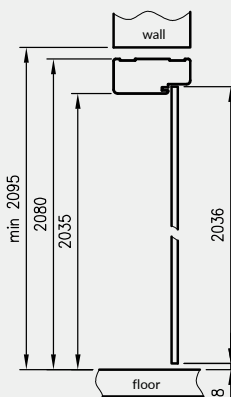

required height of wall passage 2089 mm (2095 mm for glass doors)

fixed door frame SOFT

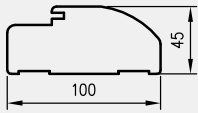

fixed door frame SOFT natura

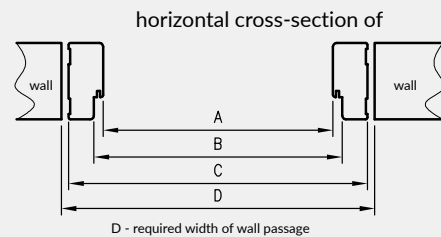
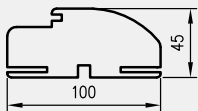

for single-leaf doors

	A	B	C	D
60	600	624	690	712
70	700	724	790	812
80	800	824	890	912
90	900	924	990	1012
100	1000	1024	1090	1112
110	1100	1124	1190	1212

for double-leaf doors

	A	B	C	D
100d	1035	1059	1125	1147
110d	1135	1159	1225	1247
120	1235	1259	1325	1347
130	1335	1359	1425	1447
140	1435	1459	1525	1547
150	1535	1559	1625	1647
160	1635	1659	1725	1747
170	1735	1759	1825	1847
180	1835	1859	1925	1947
190	1935	1959	2025	2047
200	2035	2059	2125	2147

OPTIONS AVAILABLE WITH EXTRA CHARGE

- » door frame ENTER (with latch deadbolt plate)
- » door frame SOLID
- » door frame for double leaf door:

ADJUSTABLE DOOR FRAMES

WITH K63 AND N63 ANGULAR ARCHITRAVE

CONSTRUCTION

Adjustable door frame is made of high-quality wood based MDF board. On its external side it is entirely coated with a decorative wood-imitation DRE - Cell Veneer, 3D veneer, Finish veneer, painted** - in configuration with angular architrave K63 or coated with natural veneer with angular architrave N63. Its construction allows for use in walls ranging between 75-320 mm in thickness and additional adjustment for +20 mm.

**NOTE: To ensure the highest quality of painted door frames, before painting process they are coated with special material which constitutes solid base.

APPLICATION

Adjustable door frame can be applied for:

- » interior rebated door leaf (in all frame construction door and panel door collection having size "90" and wider, door frames should be equipped with three hinges \varnothing 13,5 mm).
- » entrance doors ENTER (includes 3 hinges \varnothing 13, 5 mm, additional latch plate - extra charge 20 PLN net)
- » glass door ("ORC" they are equipped with two hinges \varnothing 15 mm, special latch plate and rubber seal strip).

SET CONTAINS

Main beam (one horizontal and two vertical elements together with masking elements), door seal, set of hinges, all necessary components for the installation of door frames in accordance with the supplied instruction. Door frames are packed in cardboard boxes.



OR/ORC cross-section with K63 architrave

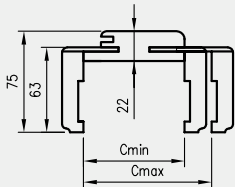

OR/ORC cross-section Natura with N63 architrave

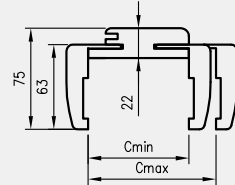

vertical cross-section of rebated door leaves

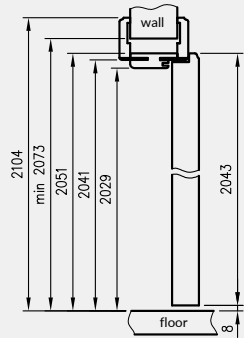

required wall passage height 2073 mm (2079 mm for glass doors)

vertical cross-section of glass doors

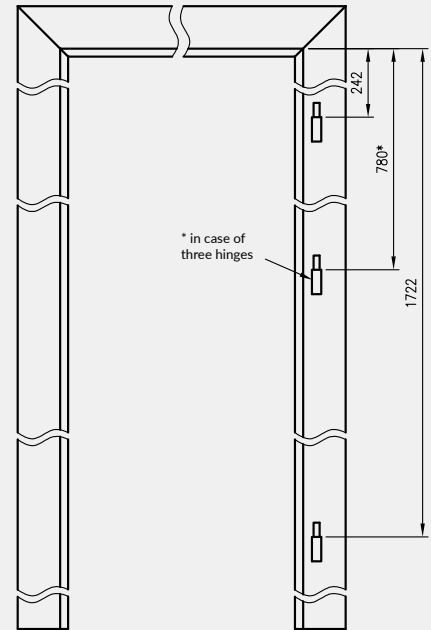
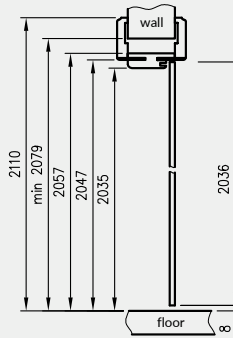

OR/ORC horizontal cross-section

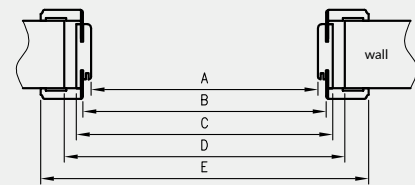

D - required width of wall passage

for single-leaf doors

	A	B	C	D	E
60	600	624	644	680	750
70	700	724	744	780	850
80	800	824	844	880	950
90	900	924	944	980	1050
100	1000	1024	1044	1080	1150
110	1100	1124	1144	1180	1250

for double-leaf doors

	A	B	C	D	E
100d	1035	1059	1079	1115	1185
110d	1135	1159	1179	1215	1285
120	1235	1259	1279	1315	1385
130	1335	1359	1379	1415	1485
140	1435	1459	1479	1515	1585
150	1535	1559	1579	1615	1685
160	1635	1659	1679	1715	1785
170	1735	1759	1779	1815	1885
180	1835	1859	1879	1915	1985
190	1935	1959	1979	2015	2085
200	2035	2059	2079	2115	2185

ADJUSTABLE DOOR FRAMES

WITH ANGULAR ARCHITRAVE T80 OR T63

CONSTRUCTION

Adjustable door frame with angular architrave T80 or T63 is equipped with a angular architrave elements with small rounding of the cross-section profile. It is made of a high-quality wood-based MDF board. On its visual side it is entirely coated with a decorative wood-imitation DRE-Cell veneer, 3D veneer, CPL laminate 0,15 - 0,2 mm, natural veneer (available only T80 architrave) or painted**. Its construction allows for use in walls ranging between 75-320 mm in thickness and additional adjustment for +20 mm.

**NOTE: To ensure the highest quality of painted door frames, before painting process they are coated with special material which constitutes solid base.

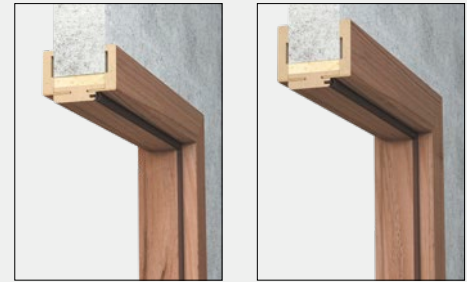

APPLICATION

Adjustable door frame can be applied for interior door leaf - rebated version and to glass doors (ORC).

SET CONTAINS

Main beam (one horizontal and two vertical elements together with masking elements), door seal, set of hinges, all necessary components for the installation of door frames in accordance with the supplied instruction. Door frames are packed in cardboard boxes.

Door frames are packed in cardboard boxes.

Door frames used as a set with frame construction doors and door frames with size "90" and wider, should be equipped with three hinges. Door frames for glass door "ORC" are equipped with two hinges \varnothing 15 mm, special latch plate and rubber seal strip.

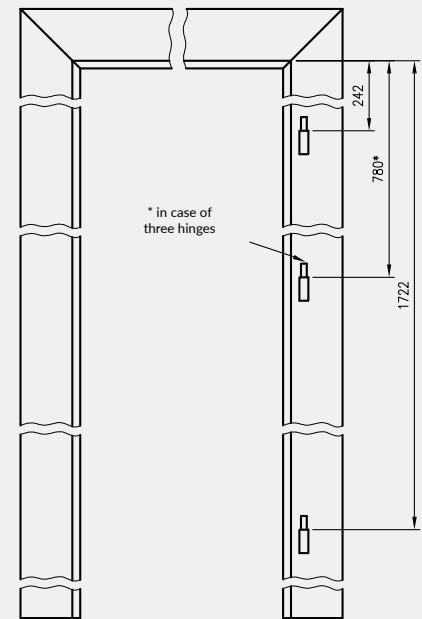

OR/ORC cross-section with T80 architrave

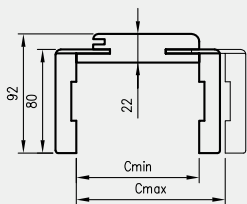

OR/ORC cross-section with T63 architrave

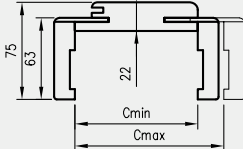

vertical cross-section of rebated door leaf with OR

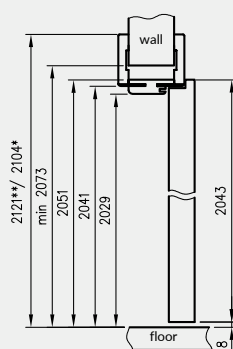

vertical cross-section of glass doors with ORC

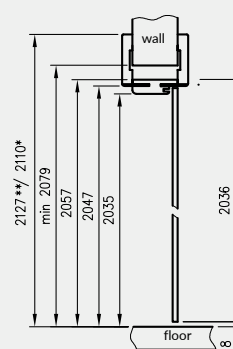

required wall passage height 2073 mm (2079 mm for glass doors)

OR/ORC horizontal cross-section

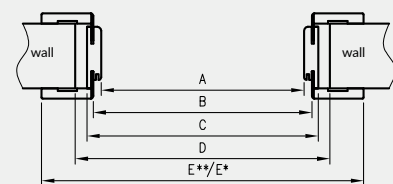

D - required width of wall passage

for single-leaf doors

	A	B	C	D	E**	E*
60	600	624	644	680	784	750
70	700	724	744	780	884	850
80	800	824	844	880	984	950
90	900	924	944	980	1084	1050
100	1000	1024	1044	1080	1184	1150
110	1100	1124	1144	1180	1284	1250

for double-leaf doors

	A	B	C	D	E**	E*
100d	1035	1059	1079	1115	1219	1185
110d	1135	1159	1179	1215	1319	1285
120	1235	1259	1279	1315	1419	1385
130	1335	1359	1379	1415	1519	1485
140	1435	1459	1479	1515	1619	1585
150	1535	1559	1579	1615	1719	1685
160	1635	1659	1679	1715	1819	1785
170	1735	1759	1779	1815	1919	1885
180	1835	1859	1879	1915	2019	1985
190	1935	1959	1979	2015	2119	2085
200	2035	2059	2079	2115	2219	2185

* dimension refer to door frame with T63 architrave

** dimension refer to door frame with T80 architrave

ADJUSTABLE DOOR FRAMES

WITH VARIABLE HEIGHTS AND ANGULAR ARCHITRAVE T80

By the fact of the interest expressed by our clients in doors of custom sizes, we have introduced to our offer collections of MODERN, PLUS and STANDARD 10 door leaf model with adjustable door frame equipped with angular architrave T80 in 3 additional heights.



APPLICATION

Adjustable door frame with variable heights with T80 architrave can be used for rebated door leaf STANDARD 10, MODERN and PLUS collections with three additional leaf height options: 1983mm, 2110mm and 2240mm.

SET CONTAINS

Main beam (one horizontal and two vertical elements together with masking elements), door seal, set of hinges, all necessary components for the installation of door frames in accordance with the supplied instruction. Door frames are packed in cardboard boxes.

Door frames are packed in cardboard boxes.

All door frames in additional options with variable heights should be equipped with three hinges.

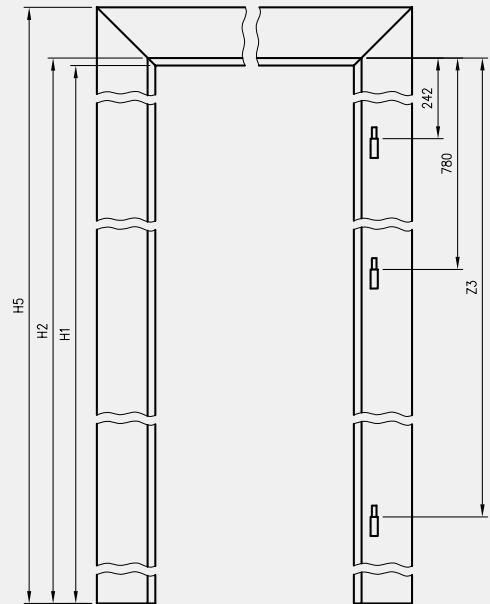

OR cross-section with T80 architrave

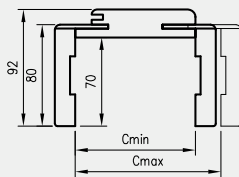

OR vertical cross-section

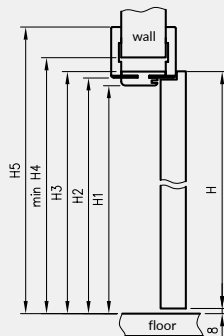

OR horizontal cross-section

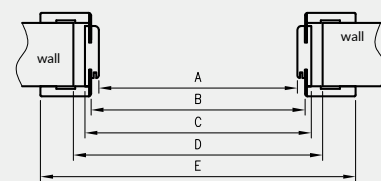

D - required width of wall passage

H	H1	H2	H3	H4	H5	Z3
1983	1969	1981	1991	2013	2061	1662
2110	2096	2108	2118	2140	2188	1789
2240	2226	2238	2248	2270	2318	1919

H - door leaf height
H4 - required wall passage height

for single-leaf doors

	A	B	C	D	E
60	600	624	644	680	784
70	700	724	744	780	884
80	800	824	844	880	984
90	900	924	944	980	1084
100	1000	1024	1044	1080	1184

for double-leaf doors

	A	B	C	D	E
120	1235	1259	1279	1315	1419
130	1335	1359	1379	1415	1519
140	1435	1459	1479	1515	1619
150	1535	1559	1579	1615	1719
160	1635	1659	1679	1715	1819
170	1735	1759	1779	1815	1919
180	1835	1859	1879	1915	2019
190	1935	1959	1979	2015	2119
200	2035	2059	2079	2115	2219

ADJUSTABLE DOOR FRAMES

NON-REBATED

CONSTRUCTION

Adjustable non-rebated door frame is made of a high-quality wood-based MDF board. On its visual side it is entirely coated with a decorative wood-imitation DRE-Cell veneer, 3D veneer, CPL laminate, natural veneer or painted**. Its construction allows to be used with door leaf with the thickness of 40 mm and its design allows for use on walls ranging between 75-320 also there is possibility for additional adjustment for +20 mm. In white mat colour there is possibility to choose connection of main beams at 90 degree.

**NOTE: To ensure the highest quality of painted door frames, before painting process they are coated with special material which constitutes solid base.

APPLICATION

Adjustable non-rebated door frame can be used with all DRE non-rebated collections of the door leaf.

SET CONTAINS

Main beam (one horizontal and two vertical elements) with wide angular architrave (80 mm) with small rounding angles of the cross-section profile (R2), door seal, a set of hinges, all necessary components for the installation of door frames in accordance with the supplied instruction. Door frames are packed in cardboard boxes.



ORB cross-section 095-300

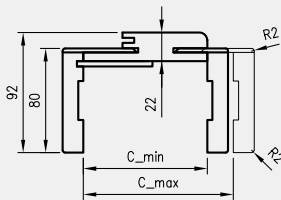

vertical cross-section of non-rebated door leaf ORB

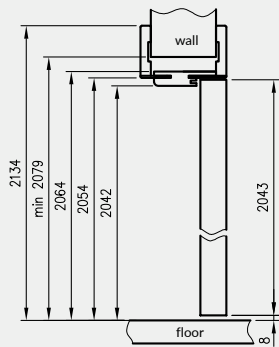

required wall passage height 2079mm

ORB cross-section 075

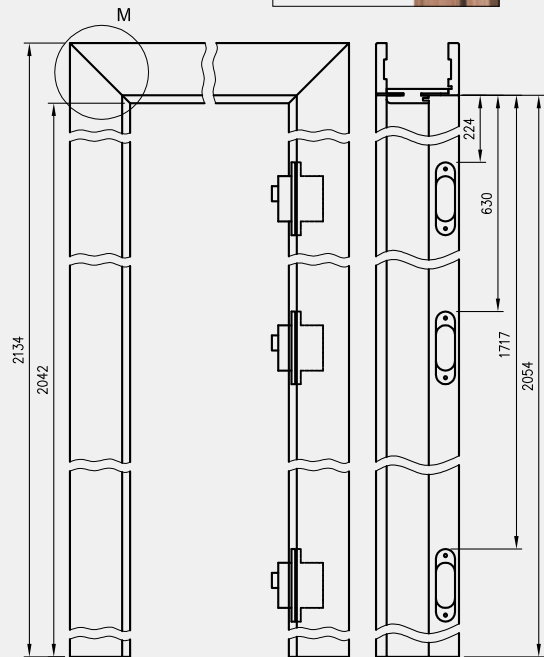
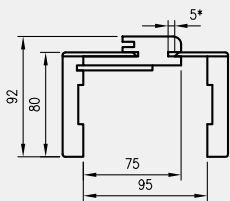

ORB horizontal cross-section

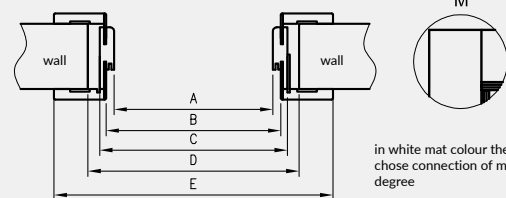

D - required width of wall passage

in white mat colour there is option to chose connection of main beams at 90 degree

*075-095 door frame has a different cross section, for a 75-89 mm wall thickness, it will be necessary to shorten pen of the adjustable angle element.

for single-leaf doors

	A	B	C	D	E
60	627	651	671	711	811
70	727	751	771	811	911
80	827	851	871	911	1011
90	927	951	971	1011	1111
100	1027	1051	1071	1111	1211

for double-leaf doors

	A	B	C	D	E
120	1274	1298	1318	1378	1458
130	1374	1398	1418	1478	1558
140	1474	1498	1518	1578	1658
150	1574	1598	1618	1678	1758
160	1674	1698	1718	1778	1858
170	1774	1798	1818	1878	1958
180	1874	1898	1918	1978	2058

ADJUSTABLE DOOR FRAMES

NON-REBATED WITH VARIABLE HEIGHTS

By the fact of interest expressed by our clients in non-rebated doors of custom sizes, we have introduced to our offer collections MODERN, PLUS and STANDARD 10 door leaf model with non-rebated adjustable door frame in 3 additional heights. Construction of the door frame is the same as in the non-rebated adjustable door frame (they vary only in height).

APPLICATION

Non-rebated adjustable door frame with variable heights can be used with non-rebated STANDARD 10, MODERN and PLUS door leaf model which are available in three additional door leaf height options: 1983 mm, 2110 mm and 2240 mm.

SET CONTAINS

Main beam (one horizontal and two vertical elements together with masking elements), door seal, set of hinges, all necessary components for the installation of door frames in accordance with the supplied instruction. Door frames are packed in cardboard boxes.

Door frames are packed in cardboard boxes.

All door frames in additional options with variable heights should be equipped with three hinges.



ORB cross-section 095-300

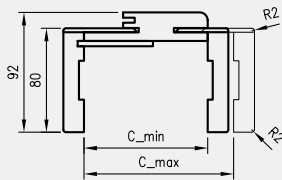

ORB cross-section 075

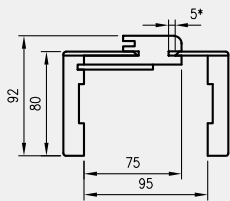

ORB vertical cross-section

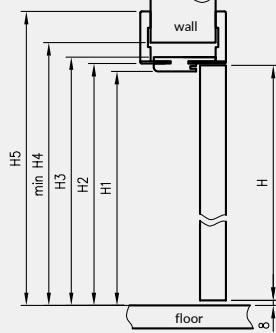

H4 - required wall passage height

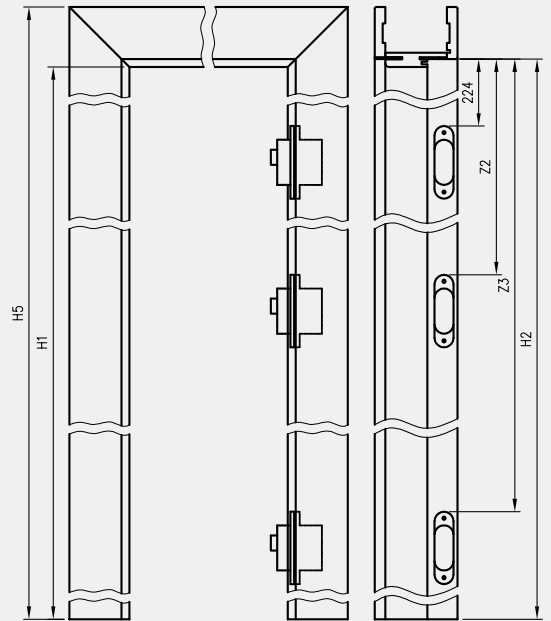

*NOTE: 075-095 door frame has a different cross-section, for a 75-89 mm wall thickness, it will be necessary to shorten pen of the moving angular architrave.

H - door leaf height	H1	H2	H3	H4	H5	Z2	Z3
1983	1982	1994	2004	2019	2074	610	1657
2110	2109	2121	2131	2146	2201	651	1784
2240	2239	2251	2261	2276	2331	695	1914

ORB horizontal cross-section

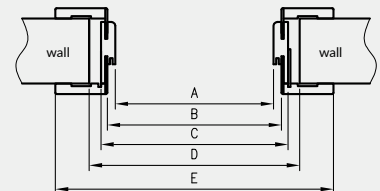

D - required width of wall passage

for single-leaf doors

	A	B	C	D	E
60	627	651	671	711	811
70	727	751	771	811	911
80	827	851	871	911	1011
90	927	951	971	1011	1111
100	1027	1051	1071	1111	1211

for double-leaf doors

	A	B	C	D	E
120	1274	1298	1318	1378	1458
130	1374	1398	1418	1478	1558
140	1474	1498	1518	1578	1658
150	1574	1598	1618	1678	1758
160	1674	1698	1718	1778	1858
170	1774	1798	1818	1878	1958
180	1874	1898	1918	1978	2058

ADJUSTABLE TUNNEL

WITH K63, N63, T63, T80 ANGULAR ARCHITRAVE

Adjustable tunnel is a decorative cover of wall passage. It can be used as a separate solution or as an integral part of the sliding wall-mounted system NT.

The adjustable tunnel is a product which is, at first glance visually similar to adjustable door frames, but with a few differences:

- » there is no possibility to mount any hinges
- » there is no latch strike plate
- » there is no channel for a gasket different heights and spans of the front and rear architraves (values E and F in tables)



TUN cross-section with K63

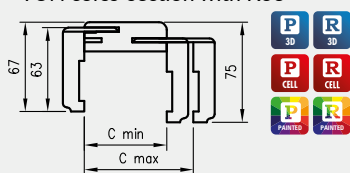

NOTE: To ensure the highest quality of painted tunnels, before painting process they are coated with special material which constitutes solid base.



TUN Natura cross-section with N63

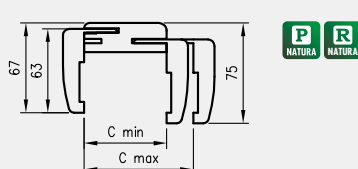

TUN cross-section with T80

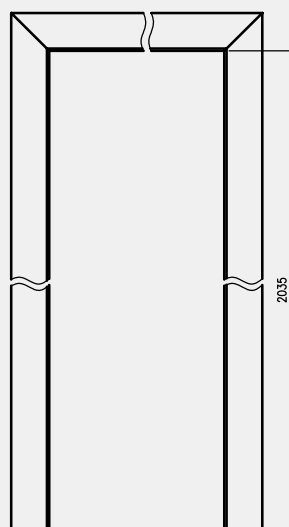
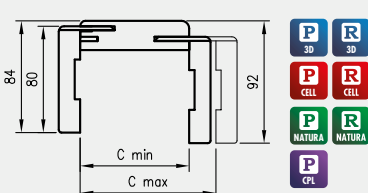

vertical cross-section of adjustable tunnel with K63 or N63

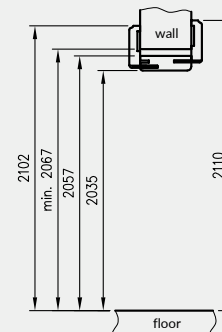

vertical cross-section of adjustable tunnel with T80

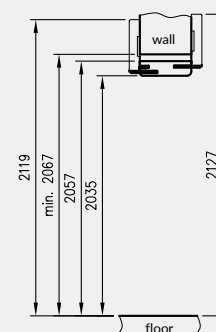

required height of wall opening 2067 mm

Single adjustable tunnel

symbol	60	70	80	90	100
A	600	700	800	900	1000
C	644	744	844	944	1044
D	664	764	864	964	1064
E	750	850	950	1050	1150
E*	784	884	984	1084	1184
F	734	834	934	1034	1134
F*	768	868	968	1068	1168

Double adjustable tunnel

symbol	120	140	160	180	200
A	1200	1400	1600	1800	2000
C	1244	1444	1644	1844	2044
D	1264	1464	1664	1864	2064
E	1350	1550	1750	1950	2150
E*	1384	1584	1784	1984	2184
F	1334	1534	1734	1934	2134
F*	1368	1568	1768	1968	2168

Adjustable tunnel cross section

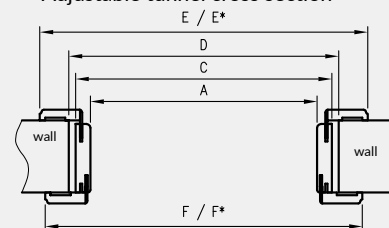

D - required width of wall passage
*refers to Adjustable Tunnel with T80

OPTIONS AVAILABLE WITH EXTRA CHARGE

Tunnel for double leaf door: +30%

HYBRID STEEL DOOR FRAME



brown mat + honey oak CPL



dark gray mat + dark gray CPL

* exemplary colour configurations of steel door frame with panel

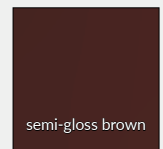
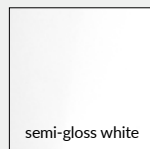
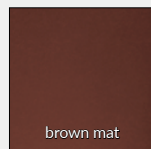
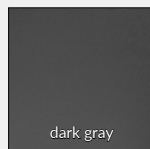

HYBRID STEEL DOOR FRAME

Steel hybrid door frame - it is an innovative solution in our sale offer, which combine solidity of metal construction with additional functionality which allows to fully finish wall passage using door frame elements made of MDF, coated with CPL laminate. Hybrid metal door frame it is combination of metal door frame with fixed width, MDF panel available in 11 optional variants of width and masking architrave. This solution allows to finish walls with thickness ranging between 137-357 mm, and additional possible adjustment up to 20 mm.

APPLICATION:

Hybrid door frame is intended to be used with entrance doors Solid and Enter model (it is equipped with 4 holes for latch bolts and multi point latch lock used in SOLID model) it can be successfully used as a complementary product with interior rebated doors - with notification that, MDF panel part is available only in CPL laminates. Assembly of the door frame is to be done on ready floor level.

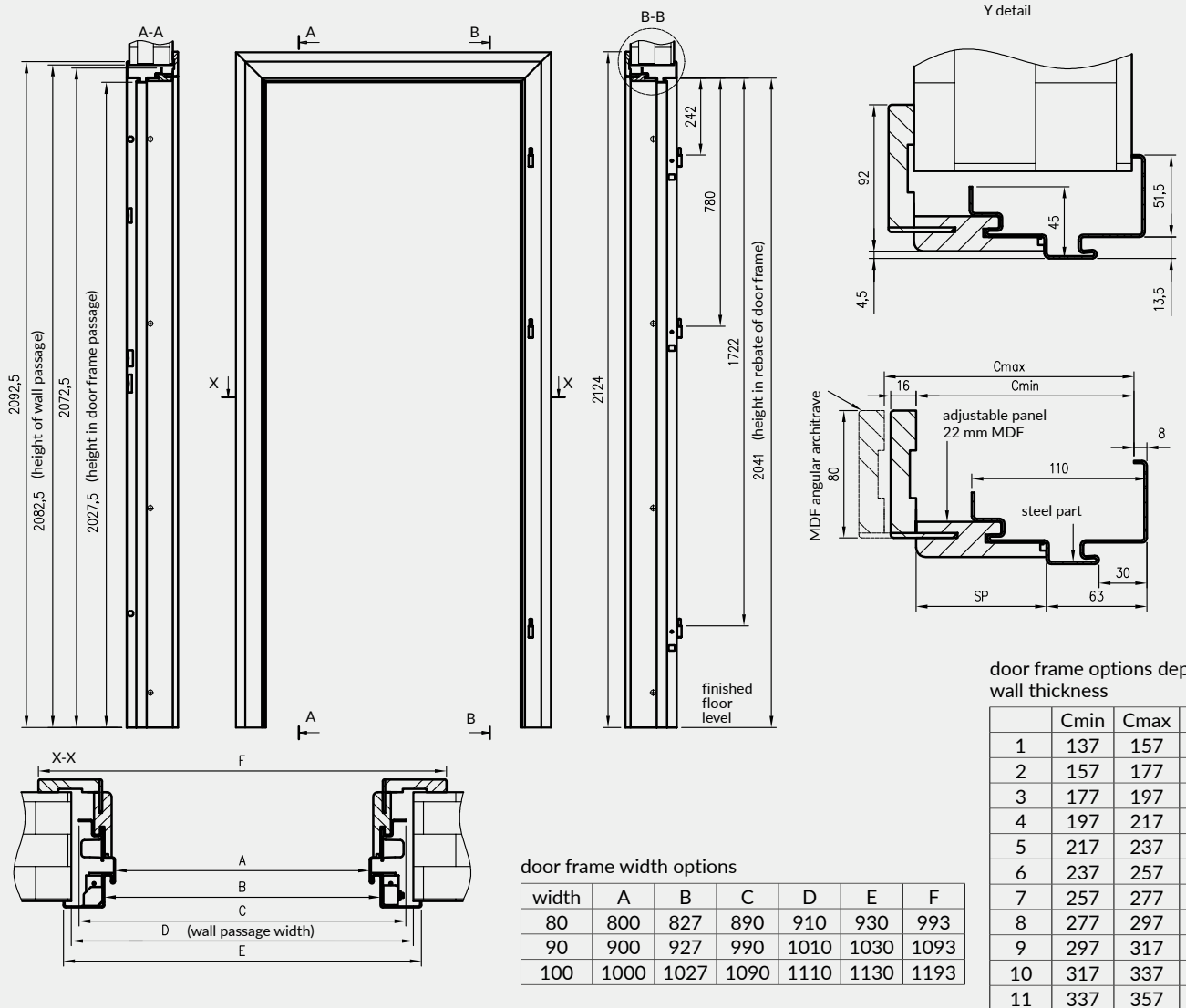

STEEL ADJUSTABLE DOOR FRAME

NEW

CONSTRUCTION

Adjustable metal door frame is made of steel low carbon sheet with 1,5 mm thickness. Vertical elements and lintel they are permanently welded together. Door frame is powder coated and available in colours from RAL pallet: 9003-white, 8017-brown, 7047-light gray, 7024-dark gray in two gloss scale (mat low structure/ semi gloss). Both external side and internal side of door frame are secured with lacquered organic protective surface. On its one side there are made 4 holes for latch bolt and bolts installed in entrance DRE doors, and on the opposite side there are 3 sockets for hinges and anti-thrust bolts.

APPLICATION

Metal door frames can be applied to interior entrance doors ENTER and SOLID.

STANDARD OPTION

- » sockets for 3 hinges
- » additional sockets for anti-thrust bolts
- » sockets for latch bolts of multi-point lock used in SOLID model

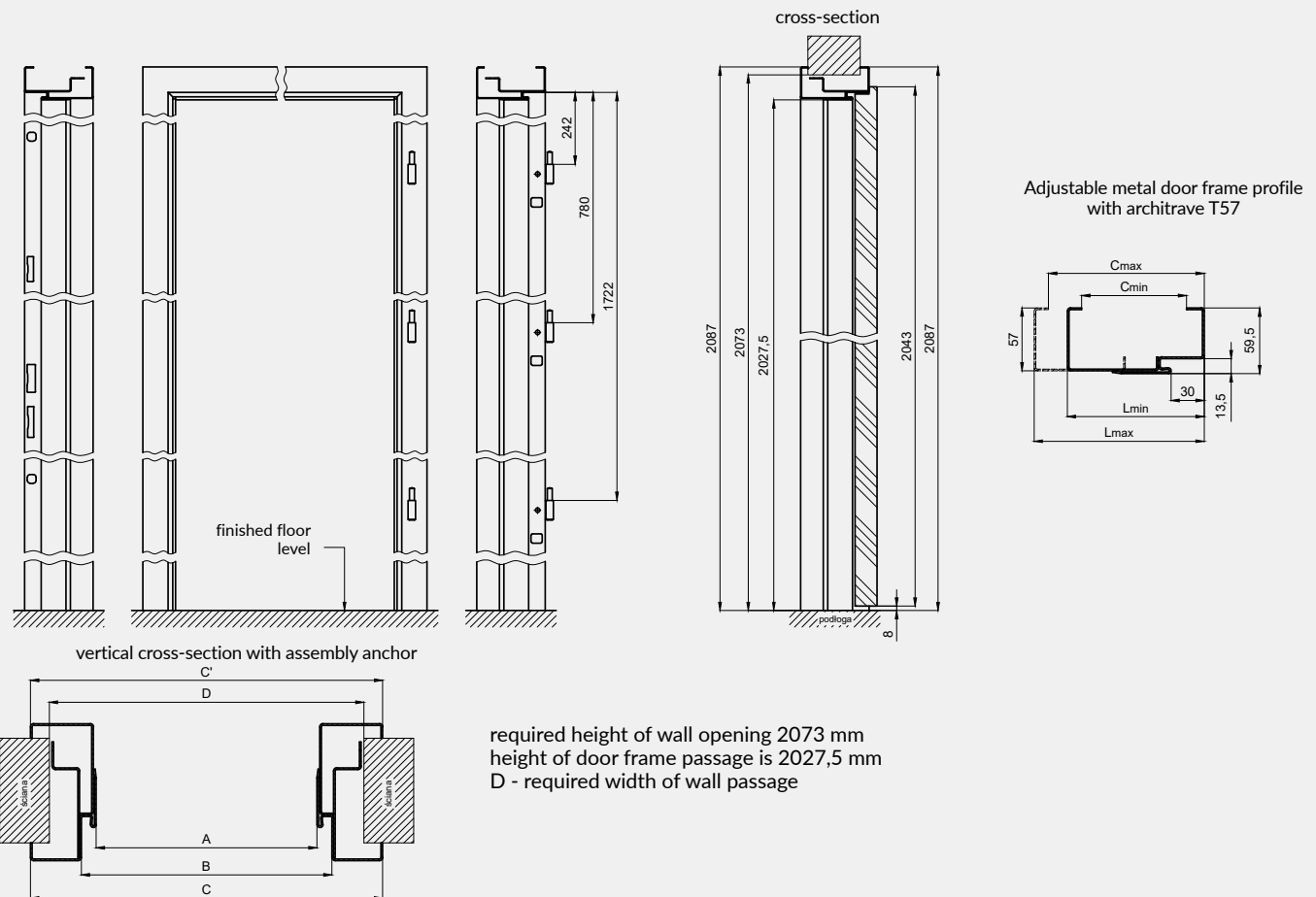

	A	B	C	D
„80”	800	827	919	890
„90”	900	927	1019	990
„100”	1000	1027	1119	1090

wall thickness		span	
Cmin	Cmax	Lmin	Lmax
95	125	124	154
125	155	154	184
155	185	184	214
185	215	214	244
215	245	244	274
245	275	274	304
275	305	304	334

CONSTRUCTION

Metal welded door frame is made of steel low carbon sheet with 1,5 mm thickness. Door frame is powder coated and available in colours from RAL pallet: 9003-white, 8017-brown, 7047-light gray, 7024-dark gray in two gloss scale (mat low structure/semi gloss). Both external side and internal side of door frame are secured with lacquered organic protective surface.

On its one side there are made 4 holes for latch bolt and bolts installed in entrance DRE doors, and on the opposite side there are 3 sockets for hinges and anti-thrust bolts.

APPLICATION

Metal door frames can be applied to interior entrance doors ENTER and SOLID. It is intended to be installed on finished floor level.

STANDARD OPTION

- » sockets for 3 hinges
- » additional sockets for anti-thrust bolts
- » sockets for latch bolts of multi-point lock used in SOLID model



Metal door frame profile

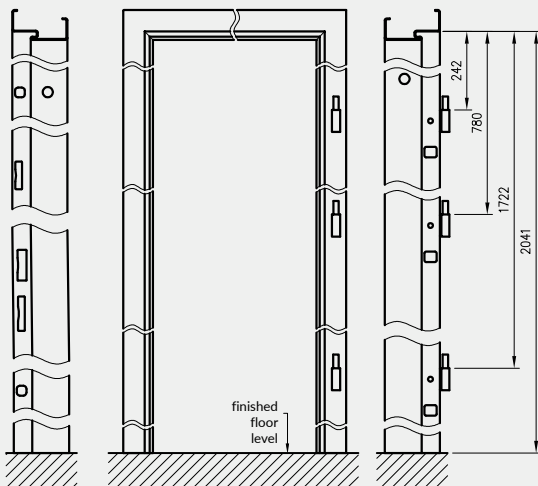
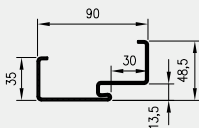

vertical cross-section

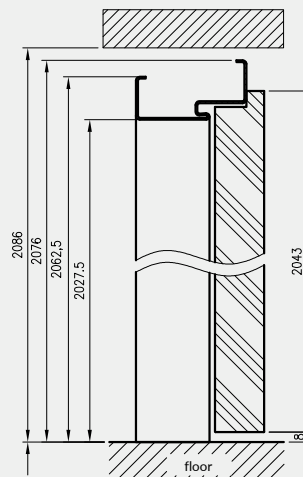

vertical cross-section optional assembly method

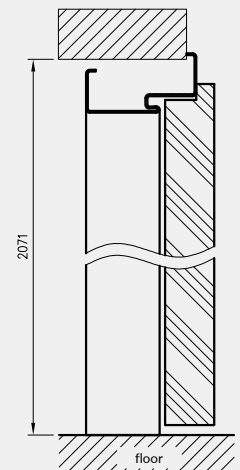

cross-section

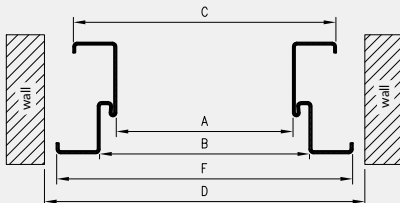

cross-section optional assembly method

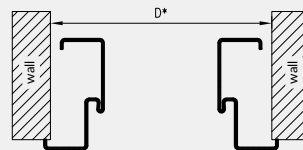

** required height of wall passage measured from the level of finished floor is 2086 mm or 2071* mm in optional assembly method

height of door frame passage is 2027,5 mm

D, D*- required width of wall passage
* optional assembly method

	A	B	C	D	D*	F
„80”	800	827	870	917	887	897
„90”	900	927	970	1017	987	997
„100”	1000	1027	1070	1117	1087	1097





handle MEDA - shiny chrome
 inserts in DRE-Cell, 3D and CPL colours



backplate for
 simple key



backplate for
 cylinder lock



backplate for
 toilet lock

SELECTED COLOURS OF INSERTS



white insert



walnut insert



sand oak insert



golden oak insert



siberian oak insert



elm tabac insert



elm anthracite insert



oak vintage insert



american walnut insert



dark wenge insert



elm insert



polish oak 3D insert



grand oak insert



gray oak CPL insert



welsh oak CPL insert



walnut CPL insert



celini walnut CPL insert



concrete 1 CPL insert

DOOR HANDLES



handle TOTAL - shiny chrome

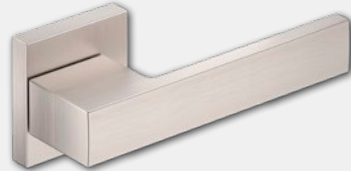

handle TOTAL - brushed nickel mat



handle DUO - graphite/chrome



handle DUO - nickel satin



door knob CRYSTAL - shiny chrome

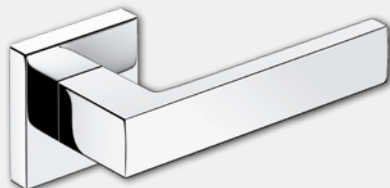

door handle CODE - shiny chrome

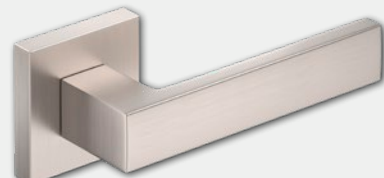

door handle CUBE - brushed nickel

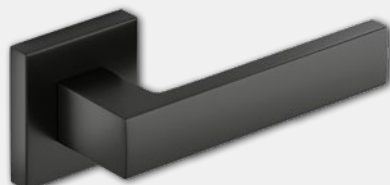

door handle COBE - black mat



backplate for simple key



backplate for cylinder lock



backplate for toilet lock



backplate for simple key



backplate for cylinder lock



backplate for toilet lock



backplate for simple key



backplate for cylinder lock



backplate for toilet lock



backplate for simple key



backplate for cylinder lock



backplate for toilet lock



backplate for simple key



backplate for cylinder lock



backplate for toilet lock



backplate for simple key



backplate for cylinder lock



backplate for toilet lock



backplate for simple key



backplate for cylinder lock



backplate for toilet lock



backplate for simple key



backplate for cylinder lock



backplate for toilet lock

NEW

NEW

NEW

DOOR HANDLES



handle MONDO - nickel satin



backplate for simple key



backplate for cylinder lock



backplate for toilet lock



handle TREND - satin nickel



backplate for simple key



backplate for cylinder lock



backplate for toilet lock



handle PRIME - nickel satin



backplate for simple key



backplate for cylinder lock



backplate for toilet lock



painted handle FORTUNA - black - chrome



backplate for simple key



backplate for cylinder lock



backplate for toilet lock



painted handle FORTUNE - white - chrome



backplate for simple key



backplate for cylinder lock



backplate for toilet lock



handle MALIBU - shiny chrome



backplate for simple key



backplate for cylinder lock



backplate for toilet lock



handle ZORBA - shiny chrome/satin



backplate for simple key



backplate for cylinder lock



backplate for toilet lock

DOOR HANDLES



handle FEBE - brushed nickel



backplate for simple key lock



backplate for cylinder lock



backplate for toilet lock



handle JOWISZ - stainless steel



backplate for simple key



backplate for cylinder lock



backplate for toilet lock



handle NOVA - stainless steel



backplate for simple key



backplate for cylinder lock



backplate for toilet lock



handle PROXIMA - stainless steel



backplate for simple key



backplate for cylinder lock



backplate for toilet lock



handle TOPAZ - stainless steel



backplate for simple key



backplate for cylinder lock



backplate for toilet lock



handle TOPAZ - stainless steel, black mat



backplate for simple key



backplate for cylinder lock



backplate for toilet lock



handle ONYX M - stainless steel



backplate for simple key



backplate for cylinder lock



backplate for toilet lock

DOOR HANDLES



handle RIO - graphite/chrome



backplate for simple key



backplate for cylinder lock



backplate for toilet lock



handle RIO - satin nickel



backplate for simple key



backplate for cylinder lock



backplate for toilet lock



handle IBIZA - graphite/chrome



backplate for simple key



backplate for cylinder lock



backplate for toilet lock



handle IBIZA - nickel satin



backplate for simple key



backplate for cylinder lock



backplate for toilet lock



handle IBIZA - silver satin



backplate for simple key



backplate for cylinder lock



backplate for toilet lock

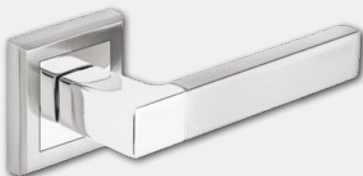

handle BETA - nickel satin



backplate for simple key



backplate for cylinder lock



backplate for toilet lock



handle EUROPA - nickel satin



backplate for simple key



backplate for cylinder lock



backplate for toilet lock

DOOR HANDLES



handle ONYX - nickel/satin



backplate for simple key



backplate for cylinder lock



backplate for toilet lock



handle QUANTA- nickel - satin



backplate for simple key



backplate for cylinder lock



backplate for toilet lock

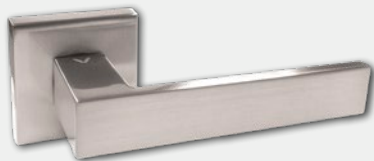

handle WARNA - nickiel satin



backplate for simple key



backplate for cylinder lock



backplate for toilet lock



handle FENIKS - chrome mat



backplate for simple key



backplate for cylinder lock



backplate for toilet lock



handle PEM - chrome mat



backplate for simple key



backplate for cylinder lock



backplate for toilet lock



handle TOM - chrome mat



backplate for simple key



backplate for cylinder lock



backplate for toilet lock



handle APUS - nickel mat



backplate for simple key



backplate for cylinder lock



backplate for toilet lock

DOOR HANDLES



handle FOKUS - nickel satin velvet



backplate for simple key



backplate for cylinder lock



backplate for toilet lock

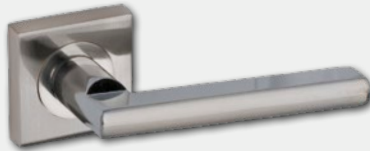

handle JANE - lacquered nickel



backplate for simple key



backplate for cylinder lock



backplate for toilet lock



handle UNO - stainless steel



backplate for simple key



backplate for cylinder lock



backplate for toilet lock



handle ROMANA - chrome/lacquered nickel



backplate for simple key



backplate for cylinder lock



backplate for toilet lock



handle MINIMAL - lacquered nickel



backplate for simple key



backplate for cylinder lock



backplate for toilet lock



handle QUBIK - lacquered nickel



backplate for simple key



backplate for cylinder lock



backplate for toilet lock



handle LIBRA - nickel satin



backplate for simple key



backplate for cylinder lock



backplate for toilet lock

DOOR HANDLES

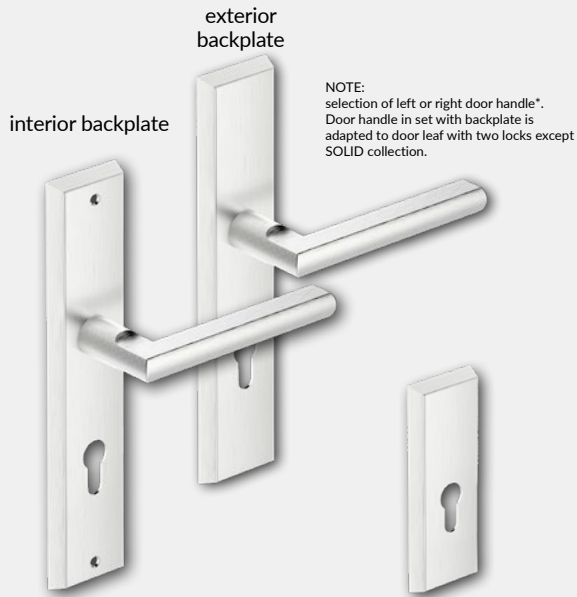

handle METRO (span 72 mm)
stainless steel for cylinder lock

upper backplate METRO
stainless steel for cylinder lock



exterior TOTAL door handle with
oblong backplate (span 72 mm)
inox plus

short upper backplate TOTAL
(span 72 mm) inox plus

*left door handle

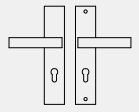

* right door handle

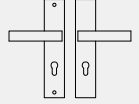

ZORBA door handle with oblong
backplate - shiny chrome/satin



handle ZORBA with oblong
backplate for simple key - shiny
chrome/satin (span 72 mm)



ZORBA door handle with oblong
backplate for cylinder lock - shiny
chrome/satin (span 72 mm)



ZORBA door handle with oblong
backplate for toilet lock - shiny
chrome/satin (span 72 mm)



PEGAZ door handle (span 72 mm)
Nickel matt for cylinder lock



TOM door handle with oblong backplate
for cylinder lock (span 72 mm) matt



technical handle STAR TEC - class IV -
stainless steel matt price for a set
(handle + backplate for cylinder lock)



backplate for
cylinder lock

VENEER COLOURS

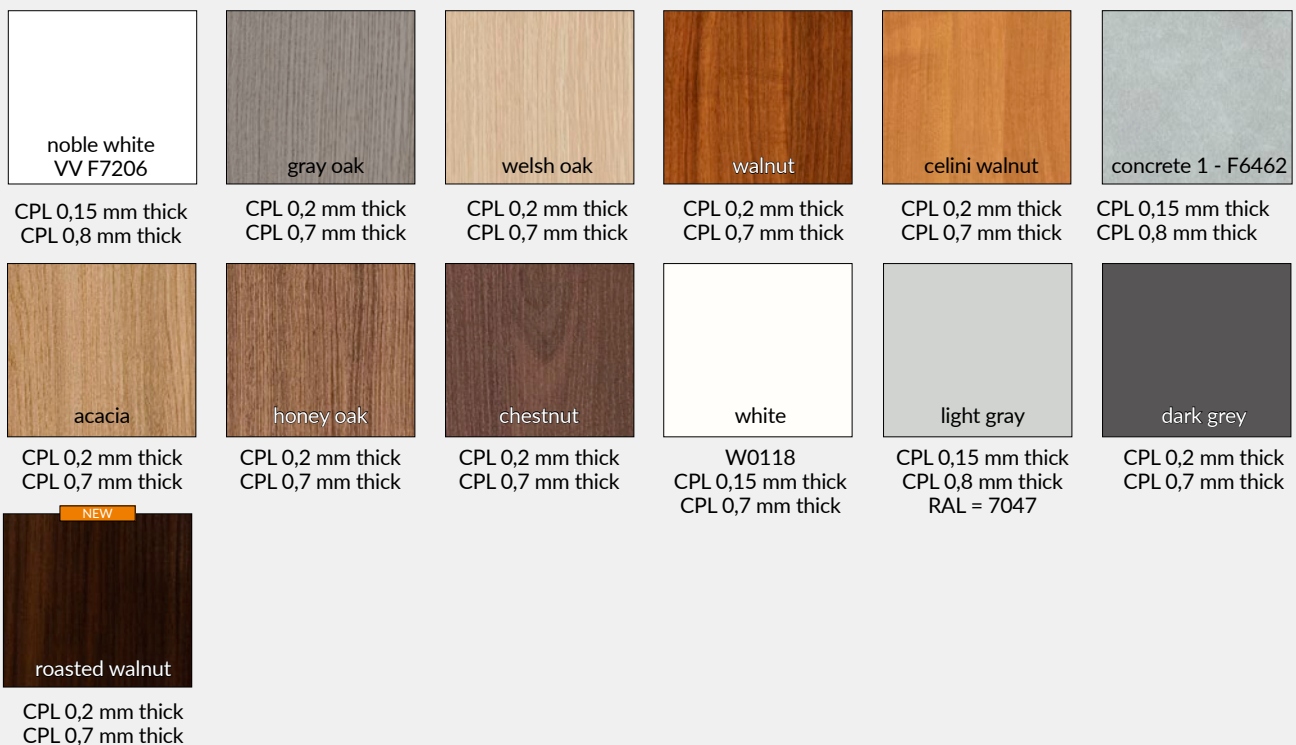

*** decor available only in horizontal wood grain.

VENEER COLOURS

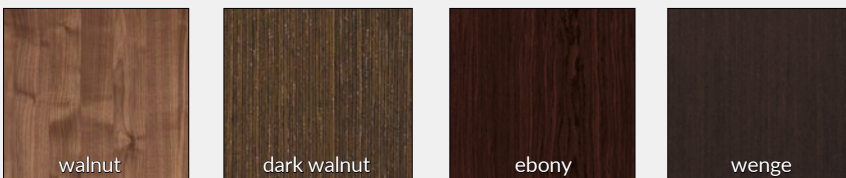
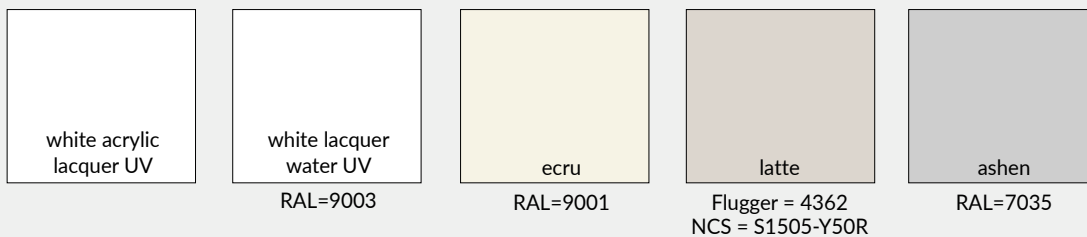

NOTE: The specificity of natural veneer is a possibility of differences in wood grain and staining. These differences cannot be the basis of the accepted complaint.

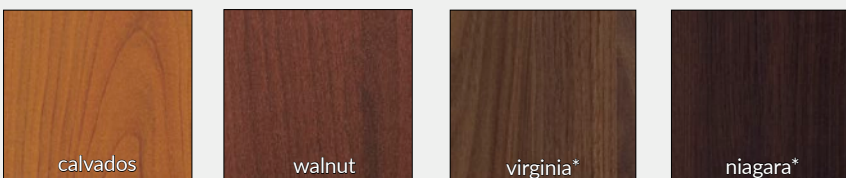

NOTE: Due to different manufacturing technology:
 » LACK and ASCADA door leaf collection - lacquered HDF board
 » door frames, architraves, Finish quarter rounds, glazing bars -coated with Finish decor
 » door leaf edges - edge banding
 There are colour differences between those elements.

* available only in SINCO door leaf, in LACK and ASCADA collections.
 ** available only in frame construction door leaf SINCO

GLASS PANE PATTERNS



pattern 1 VETRO
transparent

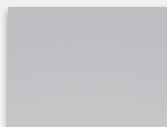

pattern 1 VETRO
decormat

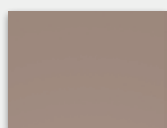

pattern 1 VETRO
decormat brown



pattern 1 VETRO
decormat graphite



pattern 2 VETRO

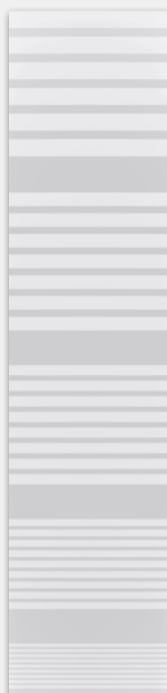

pattern 3 VETRO



pattern 4 VETRO

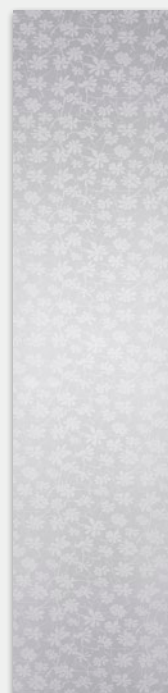

pattern 5 VETRO

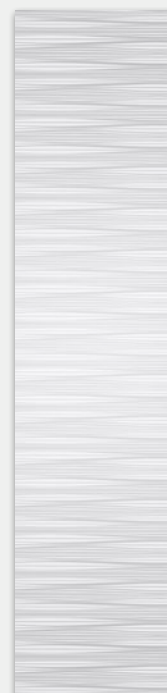

pattern 10 VETRO



pattern 11 VETRO



pattern 12 VETRO

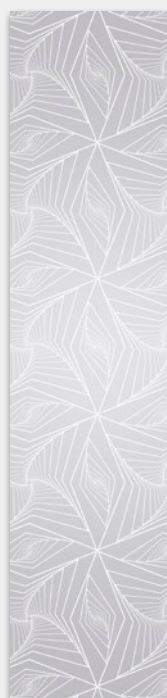

pattern 13 VETRO



pattern 14 VETRO



pattern 15 VETRO

GLASS PANE PATTERNS



mat dre



decormat graphite



decormat brown



window blind

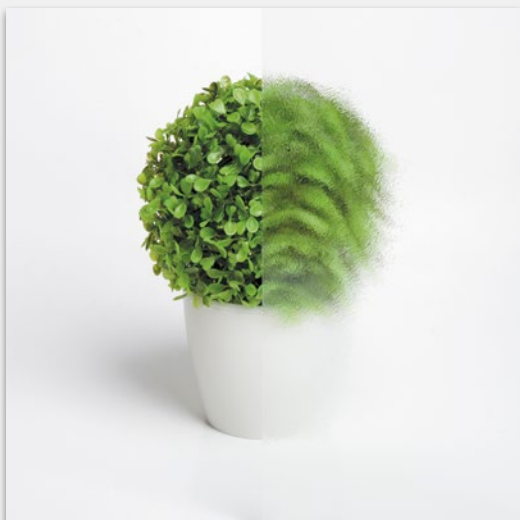

chinchila

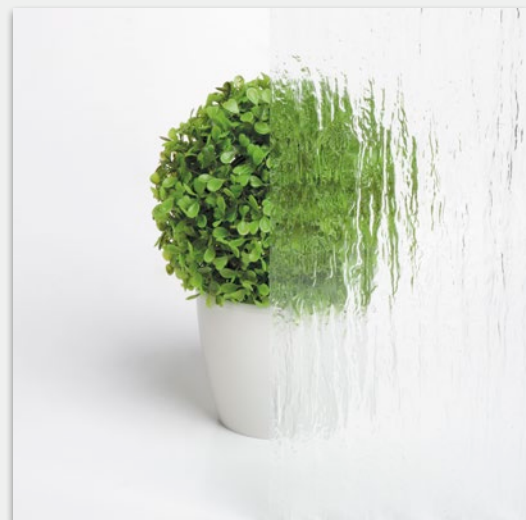

white bark

PRICES

Prices and availability of glass pane in particular models are presented on pages referred to the specific door leaf. Glass panes in our collections have obverse and reverse sides.

ARCHITRAVES AND SKIRTING BOARDS



MASKING ARCHITRAVE SOFT NATURA

application: fixed door frame SOFT natura



Set contains (for one side of the door):

horizontal element and two vertical elements, plastic clips, pins and clips.

PRICE OF ANGULAR ARCHITRAVE:

» angular architrave SOFT natura

Price for a set for one side of the door leaf

Price of the angular architrave for double-leaf doors +30%

In order to purchase angular architrave, it is necessary to specify side of the door leaf, on which, components will be mounted.

Connection of angular architrave

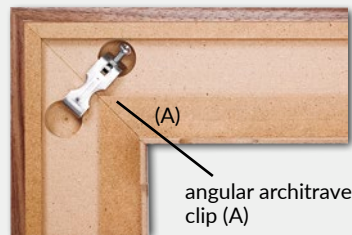

ARCHITRAVES

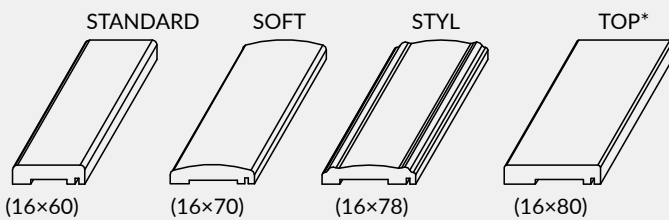

application: fixed door frame, fixed door frame SOFT

Set contains (for one side of the door):

one horizontal and two vertical components, pins and clips.

Architrave are packed in a cardboard boxes.



Connection of architrave with door frame

* architrave TOP is not available in the Finish veneer.

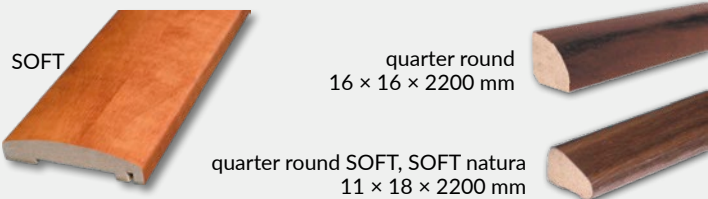

quarter round
16 × 16 × 2200 mm

quarter round SOFT, SOFT natura
11 × 18 × 2200 mm

QUARTER ROUNDS

Quarter round are used to mask the angular connection between the wall and the door frame. A single item constitutes a trade unit.

SKIRTING BOARDS



LPP2W LPP3W LPP1W LPP4W

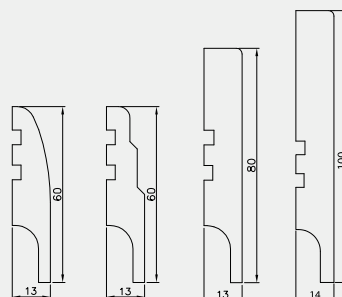

Lenght of LPP4W is 2,40 mb
It is made of moisture resistant board.
Available in: white mat, white colours.

VENTILATION ACCESSORIES AND OTHER

VENTILATION SLEEVES FOR PANEL DOORS

There is possibility to purchase a set (5 pcs) of ventilation sleeves.
DRE-Cell Decor, 3D veneer, CPL laminate and Finish veneer - white, oak, calvados, brown, silver, grey/.
NATURA - satin silver, satin gold, silver, gold.



VENTILATION SLEEVES FOR FRAME CONSTRUCTION DOOR LEAF

For frame construction door leaf, except VETRO, it is possible to use metal or plastic ventilation sleeves (3 sleeves for "60", 4 sleeves for "70", 5 sleeves for "80" - "100")

METAL VENTILATION SLEEVES

stainless steel



steel sleeve square
60 x 60 mm

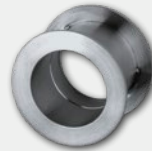

steel sleeve round
outside diameter 55 mm

PLASTIC VENTILATION SLEEVES



VENTILATION GRILLE

There is possibility to instal bathroom plastic ventilation grille, which is available in the following colours: white, beige, calvados, brown, silver, creamy, gray and ashen (except of frame construction doors, sliding system doors, fire resistant doors and SOLID, ENTER and GALERIA natura ALU) or aluminum ventilation grille (except for LACK and ASCADA).

- » plastic ventilation grille
- » aluminum ventilation grille



plastic ventilation grille



aluminum ventilation grille



ventilation undercut

VENTILATION UNDERCUT

Ventilation undercut can be applied in models of all collections (except of VETRO D, SOLID, SOLID RC2, ENTER, fire-resistant doors, sliding doors, folding doors). Ventilation undercut can be applied upon customers request.

HINGE COVERS

» (set consist of 2 pcs. for 1 hinge)
Hinge covers are adjusted to hinges with a diameter of 13,5 mm.

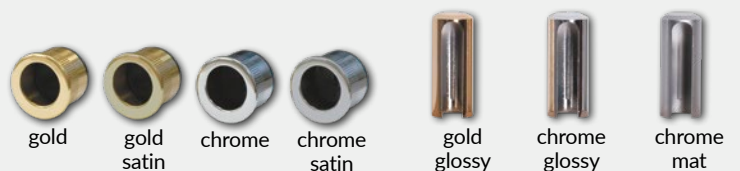

TECHNICAL INFORMATIONS

DOOR LEAF DIMENSION AND PLACEMENT OF HINGES

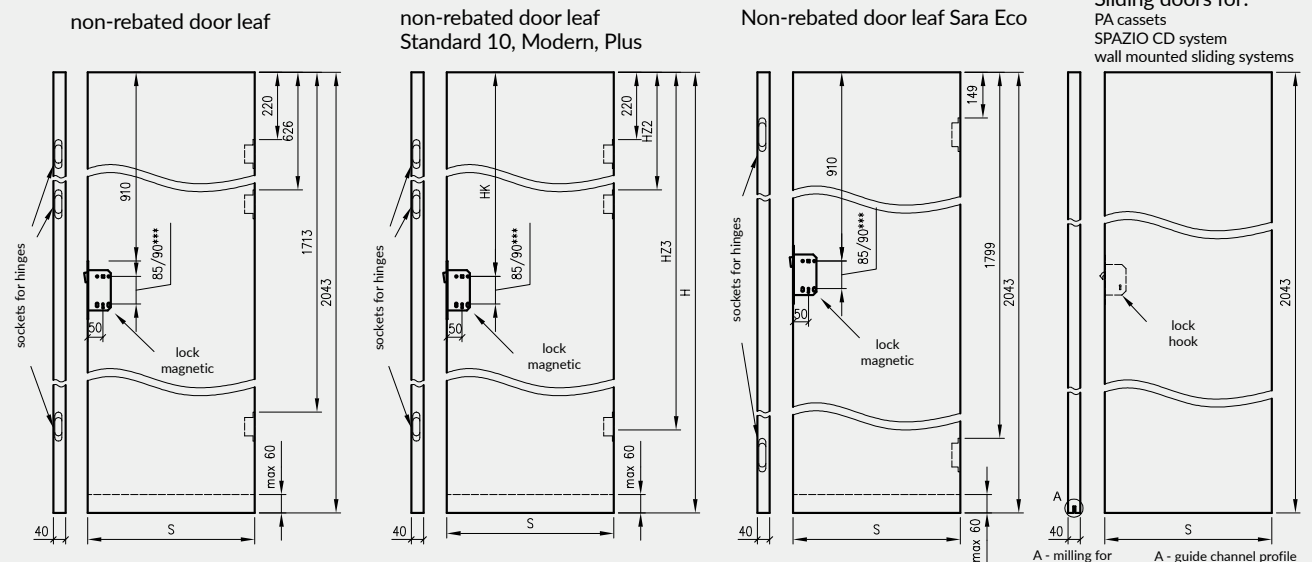
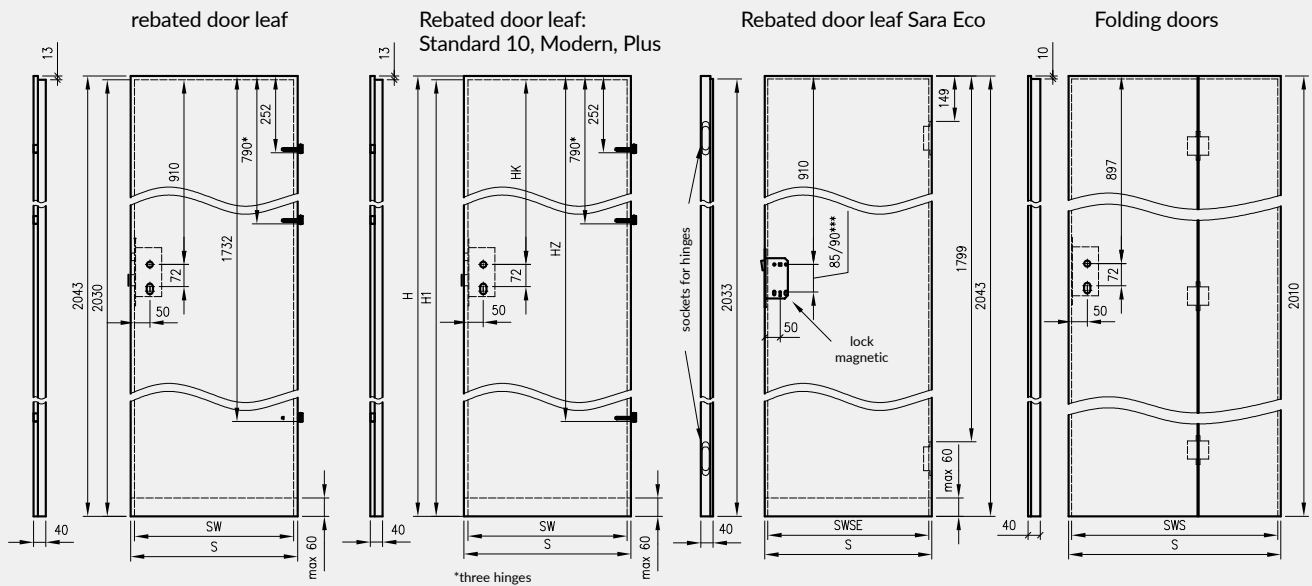

*** span in magnetic lock: 85 mm - in lock adapted for cylinder lock or 90 mm - in toilet lock and simple key lock

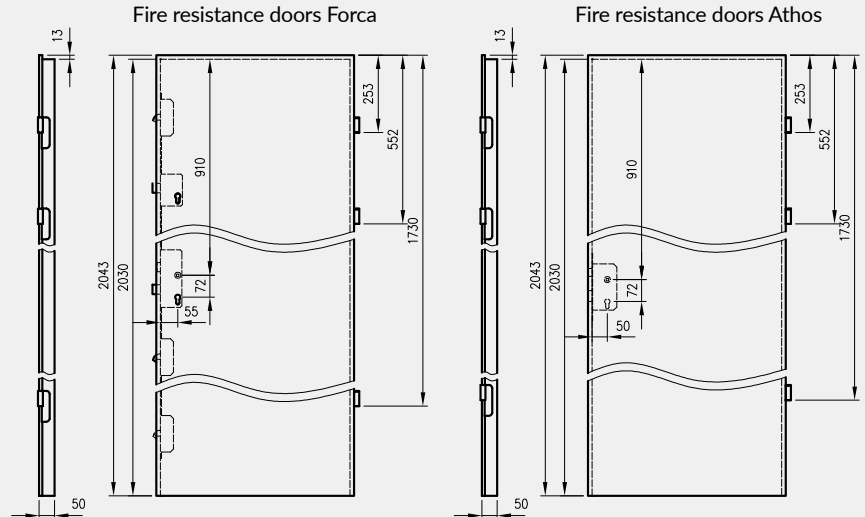
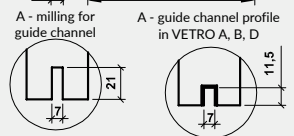

TECHNICAL INFORMATIONS

DOOR LEAF WIDTH

Symbol of the door dimension	S	SW	SWSE	SWS
„60“	644	618	-	-
„70“	744	718	-	-
„80“	844	818	824	824
„90“	944	918	924	924
„100“	1044	1018	-	1024
„110*“	1144	1118	-	-

S - total door leaf width
 SW - width in the rebate
 (refers to rebated door leaf)
 SWSE - width in the rebate of Sara Eco door leaf
 SWS - width in the rebate of folding door leaf
 * - width "110" is only available in STANDARD 10 door leaf

NOTE: Total width of "40" side panels is 444 mm.

DIMENSIONS OF THE DOOR LEAF WITH 4 VARIABLE HEIGHTS

(refers to door leaf STANDARD 10 and collections MODERN and PLUS)

H	H1	HK	HZ	HZ2	HZ3
1983	1970	850	1672	606	1653
2043	2030	910	1732	626	1713
2110	2097	977	1799	647	1780
2240	2227	1107	1929	691	1910

H - total height of the door leaf
 H1 - door leaf height in the rebate
 HK - distance from the top rebate of door leaf to the axis of the handle
 HZ - distance from the upper edge of the door leaf to the mounting point of the third hinge

DOOR LEAF HEIGHT

2043 mm - total height of rebated and non-rebated door leaf (2010 for folding doors)
 2030 mm - total height of door leaf in rebate (2033 for Sara Eco rebated door leaf, 2000 for folding doors)
 1983, 2043, 2110, 2240 mm - total possible height of STANDARD 10 door leaf and MODERN and PLUS collection (1970, 2030, 2097, 2227 mm - measured in the door leaf rebate)

SHORTENING OF DOOR LEAF

There is possibility to shorten door leaf by your own, up to 60 mm (there is no possibility to shorten following door leaf: VETRO, FIRE RESISTANT DOORS, ENTER, SOLID, SOLID RC2 door leaf with dropping seal, door leaf of all collections in the sliding version, inactive door leaf, glass doors and foldingdoors).

CLEARANCE BETWEEN DOOR LEAF AND FLOOR

Standard clearance between door leaf and finished floor is 8 mm high (15 mm in FOLDE door leaf) .

NOTES REFERED TO HINGES

In rebated door leaf: frame construction doors, entrance (Enter, Solid) and in the other collections with size wider than "90", 3 screw-in pivot hinges of \varnothing 13,5 mm are mounted. For other interior rebated leaves, there is possibility to choose 2 or 3 hinges. In SOLID RC2 door leaf there are mounted 3 threefold hinges E878.

Fire-resistance doors - FORCA and ATHOS are equipped with 3 screw in pivot hinges.

Non-rebated door leaf come with pre-milled sockets for 3 hidden concealed hinges which are attached together with non-rebated door frame.

Sara Eco rebated and non-rebated door leaf come with pre-milled sockets for 2 concealed hinges that are attached together with the door frame.

Folding doors come with 3 hidden concealed hinges which join two parts of door leaf.

Non-rebated door leaf

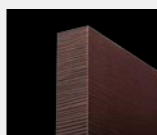

edge without rebate



lock magnetic



hinge concealed hinge

REBATED DOOR LEAF door leaf



edge straight



hinge screw-in



E878 hinge



E878 hinge SOLID RC2 door leaf

TECHNICAL INFORMATIONS

DOOR LEAF THICKNESS AND SELECTION OF PATENTED CYLINDER

Door leaf type	Door leaf thickness	proportion in the door leaf (W0/Z0)	reccommended** dimension of the patented cylinder (W/Z)	Refers to patented cylinder with door knob	
				Patented cylinder with a door knob inside (W/Z)	Patented cylinder with a door knob outside (W/Z)
rebated door leaf	40	14 / 26	25 / 40 26 / 36 26 / 41 30 / 40	25G / 40 26G / 36 26G / 41 30G / 40	25 / 40G 26 / 36G 26 / 41G 30 / 40G
rebated door leaf Sara Eco	40	24 / 16	35 / 30 36 / 26 36 / 31 40 / 30	35G / 30 36G / 26 36G / 31 40G / 30	35 / 30G 36 / 26G 36 / 31G 40 / 30G
Non-rebated door leaf	40	20 / 20	31 / 31 30 / 30 35 / 35	31G / 31 30G / 30 35G / 35	
Non-rebated door leaf Sara Eco	40	16 / 24	30 / 35 26 / 36 31 / 36 30 / 40	30G / 35 26G / 36 31G / 36 30G / 40	30 / 35G 26 / 36G 31 / 36G 30 / 40G
Folding doors	40	17/23	30/35 31/36 30/40	30G / 35 31G / 36 30G / 40	30 / 35G 31 / 36G 30 / 40G
fire resistance Athos	50	26 / 24	36 / 36 40 / 35 41 / 36	36G / 36 40G / 35 41G / 36	36 / 36G 40 / 35G 41 / 36G
fire resistance FORCA	50	26 / 24	Dragon M 40 / 35		

Patented cylinders are reversible - that is 25/40 = 40/25, 26G/36 = 36/26G

**reccommended dimensions (assuming that backplate is 10 mm thick, and patented cylinder doesn't exceed 5 mm above backplate).

fig. selection of patented cylinder dimension

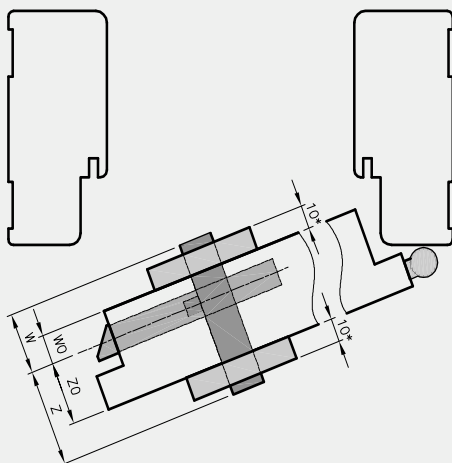
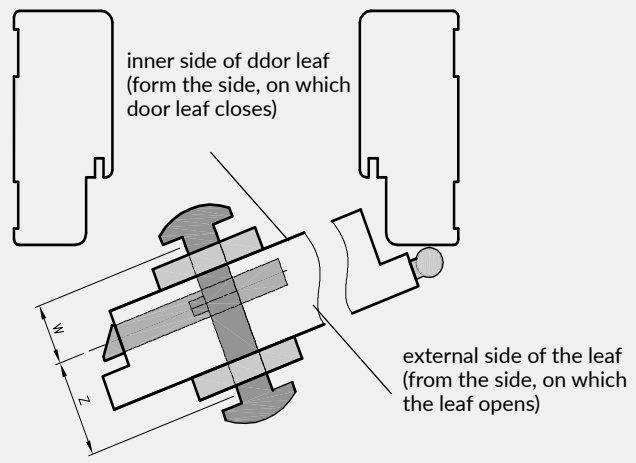

fig. selection of patented cylinder dimension with door knob



Dimension of patented cylinder is calculated using the following formula:

$W0 + \text{backplate thickness} + 2 \div 3\text{mm} / Z0 + \text{backplate thickness} + 2 \div 3\text{mm}$

where:

WO and ZO - values have been presented in the table above
thickness of the backplate - measured (presented values in above table assume that backplate is 10 mm thick)

Selection of backplate with door knob - if we want to mount a knob on:

- the inner side of door leaf - symbol of the door knob must be next to "W" dimension (see column 5 in the table)

- the external side of the leaf - symbol of the door knob must be next to "Z" dimension (see column 6 in the table)

TECHNICAL INFORMATIONS

SINGLE LEAF REBATED DOOR

We offer left, right and central door leaf

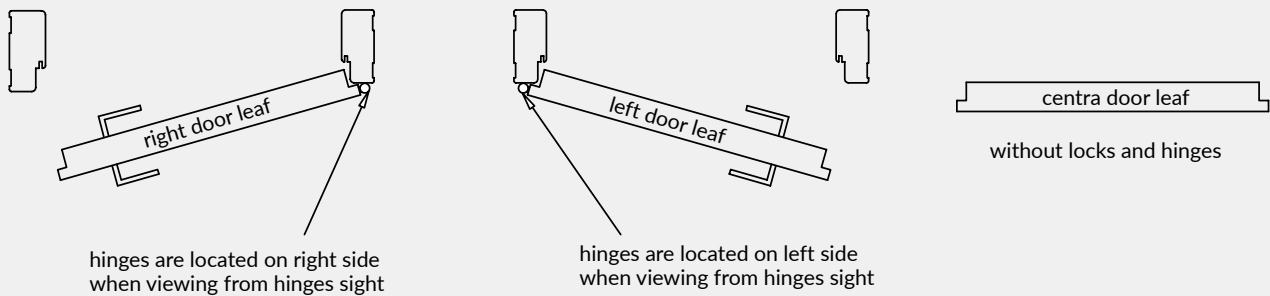

DOUBLE LEAF REBATED DOOR

We offer double leaf doors: the right - then right door leaf becomes an active one and left door leaf becomes inactive, and double left leaf - left leaf is an active one and the right one is inactive.

An active door leaf has a rebate and a lock as a standard option. In double leaf door there is available only straight edge.

Inactive door leaf comes with a "counter rebate" and additionally is equipped with a latch strike plate and a flush bolt as a standard fitting (A)

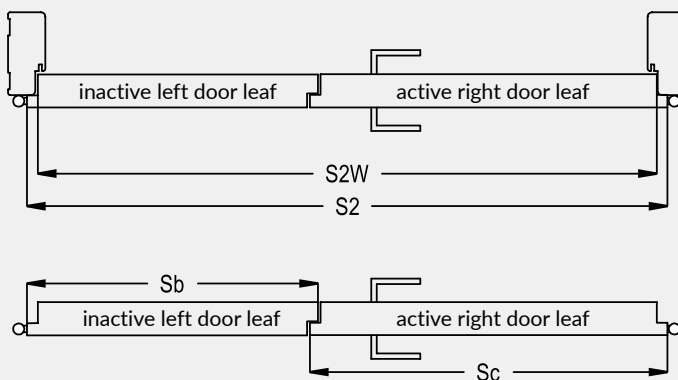

flush bolt (A)

Only door frames produced by DRE fit double-leaf doors, that is the reason that we recommend to our customers to buy doors as a complementary sets. Whole DRE set comprises of 2 door leaf and door frame.

Symbol of door dimension	dimension in [mm]		
	S2	S2W	combination* Sc+Sb
"100d"	1078	1052	644+444
"110d"	1178	1152	744+444
"120"	1278	1252	844+444; 644+644
"130"	1378	1352	944+444; 744+644; 644+744
"140"	1478	1452	1044+444; 844+644; 744+744; 644+844
"150"	1578	1552	944+644; 844+744; 744+844; 644+944
"160"	1678	1652	1044+644; 944+744; 844+844; 744+944; 644+1044
"170"	1778	1752	1044+744; 944+844; 844+944; 744+1044
"180"	1878	1852	1044+844; 944+944; 844+1044
"190"	1978	1952	1044+944; 944+1044
"200"	2078	2052	1044+1044

combination* possible combination of active (Sc) and inactive (Sb) leaf width

TECHNICAL INFORMATIONS

NON-REBATED DOOR LEAF - SLIDING VERSION

We offer left, right and central door leaf (door leaf without a lock and handle)

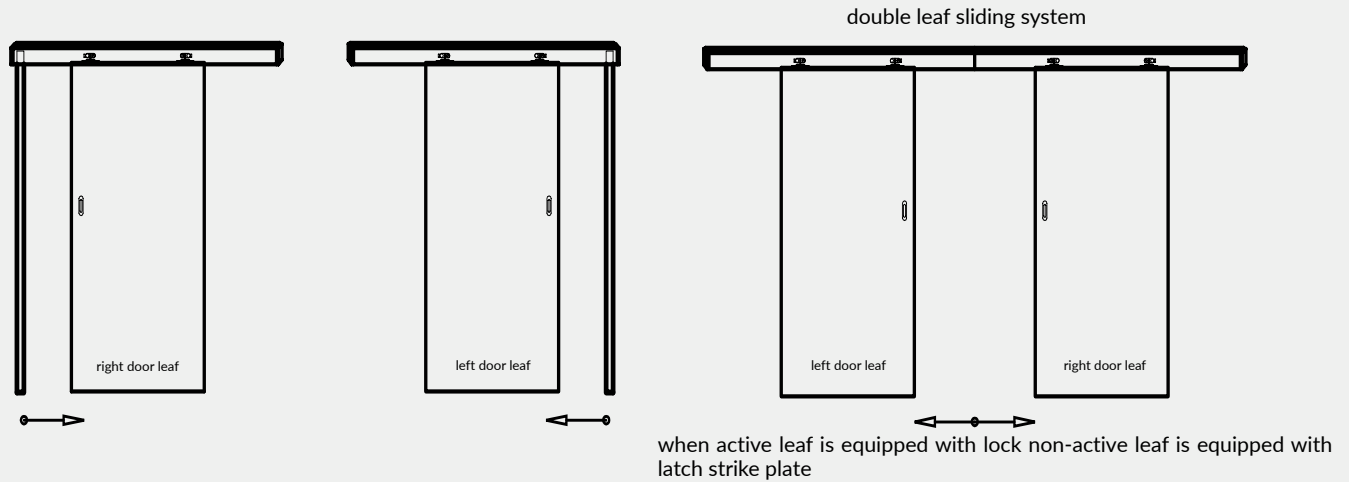

SINGLE DOOR LEAF NON-REBATED

We offer left, right and central door leaf

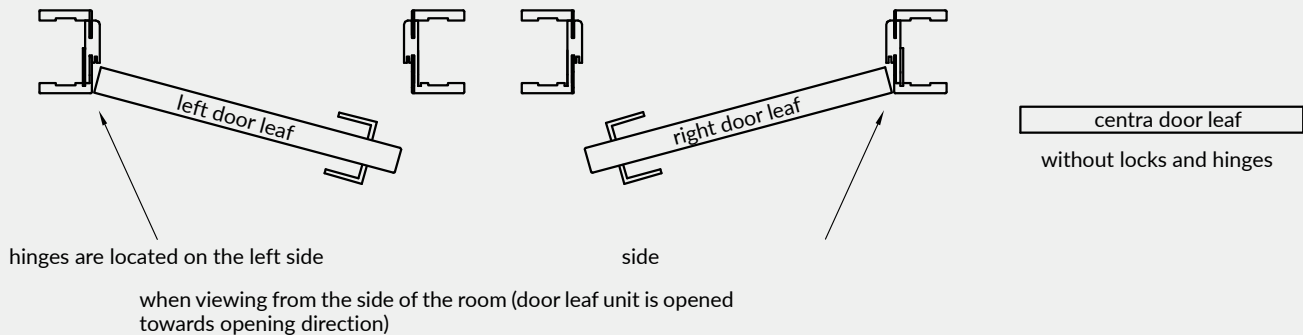

DOUBLE LEAF NON-REBATED DOOR

We offer double leaf doors: the right - then right door leaf becomes an active one and left door leaf becomes inactive, and double left leaf - left leaf is an active one and the right one is inactive.

An active door leaf has lock as a standard option. Inactive door leaf is equipped with a latch strike plate and a flush bolt as a standard fitting.

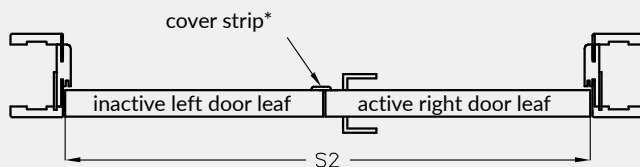

* for double leaf non-rebated doors there is possibility to purchase cover stripe width of cover stripe 30 mm

Symbol of door dimension	dimension in [mm]	
	S2	combination* Sc+Sb
"120"	1291	644+644
"130"	1391	744+644; 644+744
"140"	1491	844+644; 744+744; 644+844
"150"	1591	944+644; 844+744; 744+844; 644+944
"160"	1691	1044+644; 944+744; 844+844; 744+944; 644+1044
"170"	1791	1044+744; 944+844; 844+944; 744+1044
"180"	1891	1044+844; 944+944; 844+1044

combination* - possible combination of active (Sc) and inactive (Sb) leaf width

TECHNICAL INFORMATIONS

CONSTRUCTION OF PANEL DOORS

- » door leaf frame made of coniferous wood or MDF
- » Core: stabilising insert "honeycomb" (A), perforated chipboard (B) and in fire proof doors: chipboard
- » external board HDF 3 mm or external board HDF 4 mm (Finea, Finea B, ENTER, SOLID)
- » type of edge "karnies", straight or without rebate

- External boards of door leaf is finished with:
- a) in LACK, ASCADA collection - lacquered HDF board
 - b) in DRE-Cell veneer - decorative foil based on the polypropylene
 - c) in 3D veneer - 3D foil based on decorative paper
 - d) in CPL laminate - 0,15 -0,2 mm or 0,8 mm thick
- in natura collection - natural veneer, secured with cured varnish in UV technology

Rebated fire-resistance, anti-burglar doors FORCA EI30

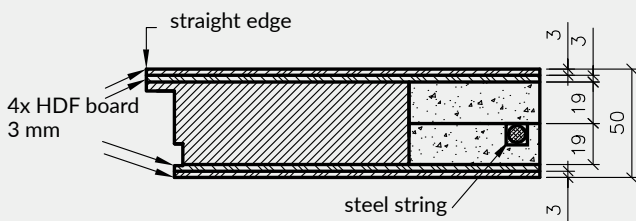

Rebated fire-resistance doors Athos EI30

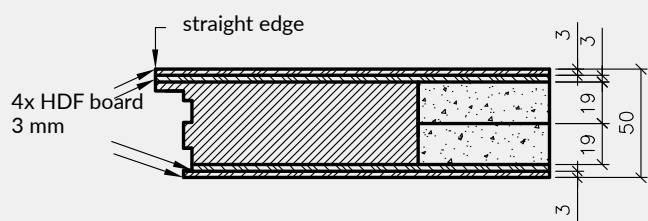

Anti-burglary door leaf SOLID RC2

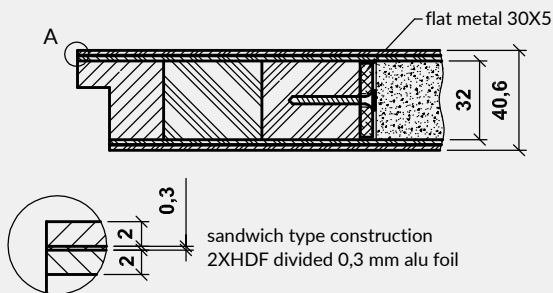

(A) stabilising insert "honeycomb"



(B) perforated chipboard

TECHNICAL INFORMATIONS

FRAME CONSTRUCTION DOORS (IS NOT REFERRED TO VETRO A,B,C,D,F)

Frame construction door leaf is entirely made of MDF:

vertical stiles are made of 40 mm MDF (except TIZANO and TIXA)

horizontal rails (exterior) are made of 35 mm MDF

horizontal rails (interior):

- 22 mm MDF in door leaf models Auri, Piano, Even, Premium, Fosca, Sinco, Tizano, Tixa, Triesta*, Ena*, Verano* and Emena* (* in Ena 1-2, Triesta 1-2, Emena 1-2, Verano 1-2, collections horizontal rail is made of 35 mm MDF - it refers to rail located next to large glass pane. While in models Ena 3-5, Verano 3-5, Emena 3-5 and Triesta 3 such a construction is referred to two rails located next to large glass pane.
- 35 mm MDF in door leaf models Nestor, Elsa, Lexa, Scala and Trevi

Horizontal cross-section of door leaf
Auri, Emena, Verano, Piano, Premium,
Fosca, Sinco, Ena, Even, Triesta

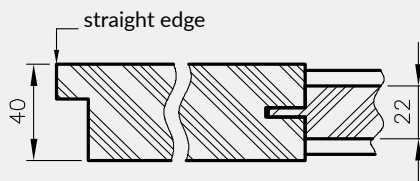

Horizontal cross-section of ELSA

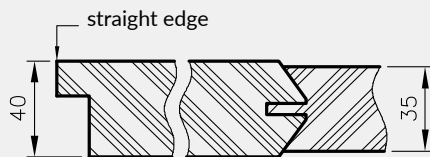

Horizontal cross-section of Tizano, Tixa

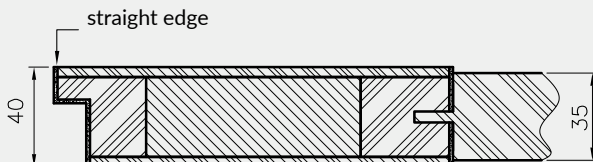

Horizontal cross-section of Ena, Verano,
Emena and Triesta (cross-section refers to
rail located next to large glass pane)

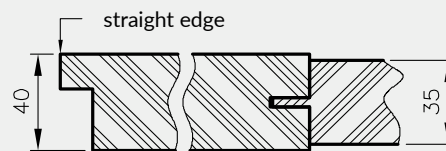

Horizontal cross-section of Nestor, Lexa

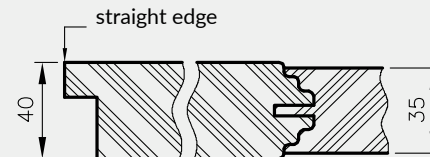

Horizontal cross-section of Scala and Trevi

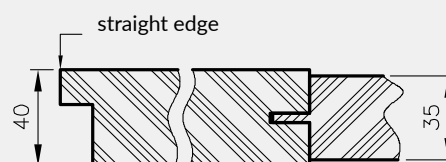

FILLINGS OF FRAME CONSTRUCTION DOOR LEAF:

Scala A; Sinco - 4 mm glass pane, flat 4 mm HDF board

Scala B - 4 mm glass pane, 19 mm MDF profiled board

Elsa A - 4 mm glass pane, flat 4 mm HDF board

Elsa B - 4 mm glass pane, 19 mm MDF profiled board

Premium 1-3 - 4 mm glass pane

Premium 4-7 - 4 mm glass pane, 4 mm HDF marquetrys made in door leaf colour

Premium 8-11 - 4 mm glass pane, 4 mm HDF marquetrys coated with silver laminate

Piano 1-6 - 4 mm glass pane, 16 mm MDF profiled board

Piano 9-12 - 4 mm glass pane, 19 mm MDF profiled board

Fosca 1-3 - 4 mm glass pane, 4 mm HDF board coated with silver laminate

Fosca 4-6 - 4 mm HDF board coated with veneer in door leaf colour

Ena - 4 mm glass pane

Trevi - 4 mm glass pane, 19 mm MDF profiled board

Triesta - 4 mm glass pane

Auri - 4 mm glass pane

Verano - 4 mm glass pane

Emena - 4 mm glass pane

Nestor, Lexa - 4 mm glass pane, 19 mm MDF profiled board

Even - 4 mm glass pane

Tizano - glass pane 4 mm

Tixa - glass pane 4 mm

profile of 19 mm MDF
(Scala B, Trevi, Piano 9-12, Elsa B, Nestor, Lexa)

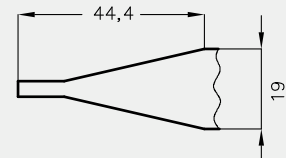

profile of 16 mm MDF
(Piano 1, 2, 5, 6)

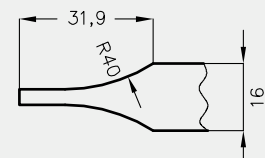

TECHNICAL INFORMATIONS

KICK PLATES

Kick plates so called „OKOPNIKI“ it is finishing solution for selected panel door models with straight edge.

We offer door leaf covered with thin 0.6 mm metal sheets made of stainless steel optional bottom and middle panels. It is also possible that both of panels are instaled at the same time on the selected door leaf. Height of the panel is 300 mm.

Door leaf with kick plates must be filled with perforated chipboard.



There is possibility to order door leaf with bottom panel and ventilation undercut.

NOTE: If you wish to place an order, please contact the Customer Service Department.

REMAINING TECHNICAL INFORMATIONS:

1. While maintaining standard dimensions of door leaf and door frame, clearance between "finished" floor and bottom edge of the door leaf is 8 mm (in Folde it is 15 mm). In order to reduce clearance, door frame should be appropriately shortened at the bottom.

2. Note! Prior to the purchase and assembly of construction woodwork, check whether the selected type of joinery meet technical requirements of the project and technical drawings, it is particularly necessary to make sure that the construction of walls and ceilings allows for the mounting of construction woodwork of weight specified in the table below:

	door leaf			DOOR FRAMES		other products	
	interior	entrance	fire-resistance	adjustable	fixed	Adjustable tunnel	Sliding system
Max weight	50 kg*	50 kg*	105 kg*	40 kg	20 kg	40 kg	20 kg

* max weight of single door leaf

3. Door leaf is wrapped in shrink film and the edges are additionally protected with Styrofoam or cardboard inserts.

4. Price of door leaf does not include door handles, backplates and patented cylinders (with the exception of SCALA A and B collections in rebated and non-rebated versions in DRE-Cell veneer and 3D veneer also excluding NESTOR and ELSA collections in rebated and non-rebated version in DRE-Cell veneer and 3D veneer, where handle and backplate come free-of-charge).

5. It is possible to purchase doors and door frames CENTRA (in this option there is no sockets for the lock and hinges - option is not available for fire doors, ENTER/SOLID, SOLID RC2, Sara Eco, FOLDE) at a price of a similar product equipped with hardware and pre-milled sockets. CENTRA door frames come with door seal. Set does not include hardware.

TECHNICAL INFORMATIONS

6. Under the current regulations, doors to the bathroom, wash room and a separate toilets must be opened to the outdoors have width of at least 0,8 meter and height of 2 meter and also have on the bottom part openings with their total surface not smaller than 0,022 m², in order to fulfill correct air circulation. Door ventilation surface is the sum of the available ventilation components: ventilation grille (ensures the ventilation surface of 0.022 m² in all widths of doors) or ventilation undercut or ventilation sleeves, and the surface of the ground clearance between door leaf and the floor.

Ensuring ventilation surface for rebated doors**

Symbol of door leaf dimension	doors with ventilation sleeves		doors with ventilation undercut	
	ventilation surface of sleeves and the clearance 8 mm [m ²]	required clearance to meet ventilation requirements [in mm]	ventilation surface of the undercut and the clearance 8 mm [m ²]	required clearance to meet ventilation requirements [in mm]
"100"	0,011	19*	0,033	0
"90"	0,010	21*	0,029	1
"80"	0,009	24*	0,025	4
"70"	0,008	28*	0,021	14*
"60"	0,007	33*	0,018	35*

Ensuring ventilation surface for Sara Eco doors and all non-rebated doors

Symbol of door leaf dimension	doors with ventilation sleeves		doors with ventilation undercut	
	ventilation surface of sleeves and the clearance 8 mm [m ²]	required clearance to meet ventilation requirements [in mm]	ventilation surface of the undercut and the clearance 8 mm [m ²]	required clearance to meet ventilation requirements [in mm]
"100"	0,0112	19*	0,033	0
"90"	0,0104	21*	0,029	1
"80"	0,0096	23*	0,025	4
"70"	0,0082	27*	0,021	12*
"60"	0,0074	32*	0,018	31*

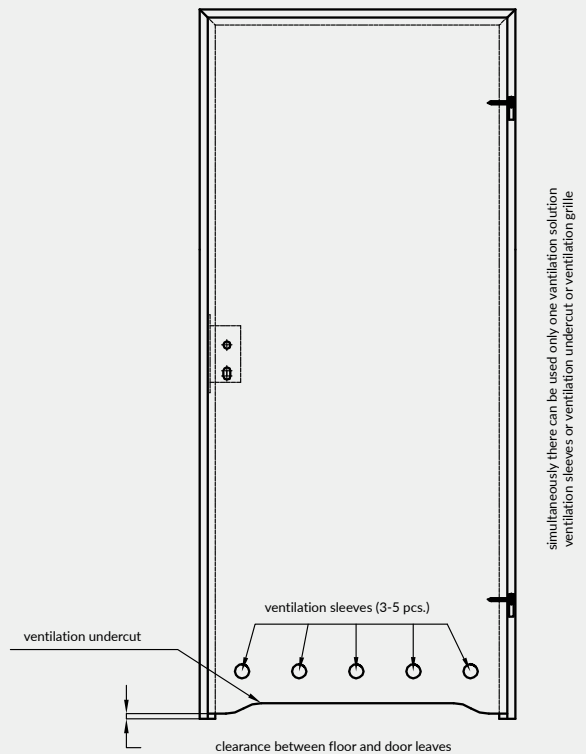

The above - stated required clearance height of the space under the door assures total ventilation surface of 0.022 m². The standard clearance for door leaf is 8mm high.

* it is necessary to increase the clearance to the specified height by shortening door leaf at the bottom (when such a shortening is possible - see**)

** exceptions which are not indicated in the table (door leaf that cannot be shortened):

- collection Vetro A and C - the use of ventilation undercut in the door with a width of "80" - "100" and a standard ground clearance of the door (8 mm) will fulfill ventilation requirements.
- collections Vetro B and D - do not meet ventilation requirements.
- sliding door leaf - due to design of the sliding system (distance from the wall/tunnel - about 12 mm), door leaf meet ventilation requirement without need for additional options.

there is no possibility to shorten double leaf doors and folding doors FOLDE.

VENTILATION UNDERCUT

standard ventilation undercut

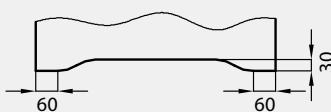

ventilation undercut in door leaf with natural veneer with „70" - „90" width

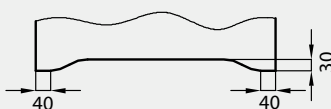

ventilation undercut in door leaf Vetro A and C

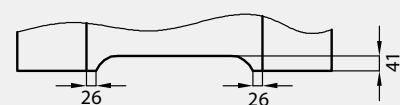

ventilation undercut in door leaf Vetro B

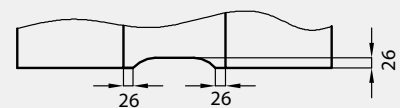



EVEN - ecru

Producer provides 24 months of warranty for door leaves and door frames.
More technical informations and informations referred to assembly process are available in product guarantee card.

This product catalogue shall not constitute an offer under the regulations of the Civil Code and is published only for information purposes. Information provided in this catalogue was up-to-date on the day the catalogue was published. Due to the company policy of constant development DRE reserves the right to introduce (without prior notice) of changes to technical parameters, equipment, extended warranty conditions and product specification. The actual colours may vary from the colours printed in this catalogue. We reserve the right to errors in print.

Technical approvals:

Technical Approval ITB AT-15-6243/2015 (rebated interior doors)
Technical Approval ITB AT-15-7783/2014 (sliding system)
Technical Approval ITB AT-15-8693/2011 (non-rebated interior doors)
Technical Approval ITB AT-15-9248/2014 (SARA ECO doors)
Technical Approval ITB AT-15-9363/2014 (fire resistance doors FORCA, ATHOS)
Technical Approval ITB AT-15-8359/2010 (glass doors)
Technical Approval ITB AT-15-9673/2016 (folding doors and sliding system glass doors)
National Technical Assessment ITB-KOT-2017/0011 edition first (ENTER/SOLID/SOLID RC2)